

# ECS-8000 USER

Intel® Quad Core™ i7 (Broadwell-H) Fanless Embedded System  
High Performance, Rugged, Extended Temp, Power Protection

# Manual

## Record of Revision

---

Version	Date	Page	Description	Remark
0.1	02/26/2016	All	Preliminary Release	
1.0	03/11/2016	All	Office Release	
1.1	03/23/2021	3, 7, 9, 21	Update	

## Disclaimer

This manual is released by Vecow Co., Ltd. for reference purpose only. All product offerings and specifications are subject to change without prior notice. It does not represent commitment of Vecow Co., Ltd. Vecow shall not be liable for direct, indirect, special, incidental, or consequential damages arising out of the use of the product or documentation, nor for any infringements upon the rights of third parties, which may result from such use.

## Declaration of Conformity

**FCC** This equipment has been tested and found to comply with the limits for a Class A digital device, pursuant to part 15 of the FCC Rules. These limits are designed to provide reasonable protection against harmful interference when the equipment is operated in a commercial environment. This equipment generates, uses, and can radiate radio frequency energy and, if not installed and used in accordance with the instruction manual, may cause harmful interference to radio communications. Operation of this equipment in a residential area is likely to cause harmful interference in which case the user will be required to correct the interference at his own expense.

**CE** The product (s) described in this manual complies with all applicable European Union (CE) directives if it has a CE marking. For computer systems to remain CE compliant, only CE-compliant parts may be used. Maintaining CE compliance also requires proper cable and cabling techniques.

## Copyright and Trademarks

This document contains proprietary information protected by copyright. No part of this publication may be reproduced in any form or by any means, electric, photocopying, recording or otherwise, without prior written authorization by Vecow Co., Ltd. The rights of all the brand names, product names and trademarks belong to their respective owners.

# Order Information

---

Part Number	Description
ECS-8000-PoER850Q	ECS-8000 Fanless Embedded System, Quad Core 5th Gen Intel® Core™ i7-5850EQ Processor (Broadwell-H), 6 GbE LAN with 4 PoE+, 2 Front-access SSD Tray, 4 COM, 7 USB, 2 SIM, Isolated DIO, 16 GPIO
ECS-8000-PoER700Q	ECS-8000 Fanless Embedded System, Quad Core 5th Gen Intel® Core™ i7-5700EQ Processor (Broadwell-H), 6 GbE LAN with 4 PoE+, 2 Front-access SSD Tray, 4 COM, 7 USB, 2 SIM, Isolated DIO, 16 GPIO
ECS-8000-PoE850Q	ECS-8000 Fanless Embedded System, Quad Core 5th Gen Intel® Core™ i7-5850EQ Processor (Broadwell-H), 6 GbE LAN with 4 PoE+, 4 COM, 7 USB, 2 SIM, Isolated DIO, 16 GPIO
ECS-8000-PoE700Q	ECS-8000 Fanless Embedded System, Quad Core 5th Gen Intel® Core™ i7-5700EQ Processor (Broadwell-H), 6 GbE LAN with 4 PoE+, 4 COM, 7 USB, 2 SIM, Isolated DIO, 16 GPIO
ECS-8000-2G850Q	ECS-8000 Fanless Embedded System, Quad Core 5th Gen Intel® Core™ i7-5850EQ Processor (Broadwell-H), 2 GbE LAN, 4 COM, 7 USB, 2 SIM, 32 GPIO
ECS-8000-2G700Q	ECS-8000 Fanless Embedded System, Quad Core 5th Gen Intel® Core™ i7-5700EQ Processor (Broadwell-H), 2 GbE LAN, 4 COM, 7 USB, 2 SIM, 32 GPIO
ECS-8000-2R850Q	ECS-8000 Fanless Embedded System, Quad Core 5th Gen Intel® Core™ i7-5850EQ Processor (Broadwell-H), 2 GbE LAN, 2 Front-access SSD Tray, 4 COM, 7 USB, 2 SIM, 32 GPIO
ECS-8000-2R700Q	ECS-8000 Fanless Embedded System, Quad Core 5th Gen Intel® Core™ i7-5700EQ Processor (Broadwell-H), 2 GbE LAN, 2 Front-access SSD Tray, 4 COM, 7 USB, 2 SIM, 32 GPIO

## Optional Accessories

---

Part Number	Description
M340L-W28M1	Vecow DDR3L 4GB 1333/1066 MHz RAM, Wide Temperature -40°C to +85°C
DDR3L8G	Certified DDR3L-1600 8G RAM
DDR3L4G	Certified DDR3L-1600 4G RAM
PWA-120W	120W, 24V, 90VAC to 264VAC Power Adapter with 3-pin Terminal Block
PWA-120WM4P	120W, 24V, 90VAC to 264VAC Power Adaptor with 4-pin Mini-DIN Connector
PWA-160W-WT	160W, 24V, 85VAC to 264VAC Power Adaptor with 3-pin Terminal Block, Wide Temperature -30°C to +70°C
TMBK-20P-100	Terminal Block 20-pin to SCSI, 100cm
TMBK-20P-500	Terminal Block 20-pin to SCSI, 500cm
TMB-SCSI-20P	Terminal Board with One 20-pin SCSI Connector and DIN-Rail Mounting
VESA Mount	VESA Mounting Kit
DIN-RAIL	DIN Rail Kit
Rack Mount	2U Rackmount Kit
3G Module	Mini PCIe 3G/GPS Module with Antenna
4G Module	Mini PCIe 4G/GPS Module with Antenna
WiFi & Bluetooth Module	Intel® Mini PCIe WiFi & Bluetooth Module with Antenna

# Table of Contents

<b>CHAPTER 1</b>	<b>GENERAL INTRODUCTION</b>	<b>1</b>
1.1	Overview	1
1.2	Features	2
1.3	Product Specification	2
1.3.1	Specifications of ECS-8000-PoER	2
1.3.2	Specifications of ECS-8000-PoE	4
1.3.3	Specifications of ECS-8000-2G	6
1.3.4	Specifications of ECS-8000-2R	9
1.4	Supported CPU List	11
1.5	Mechanical Dimensions	12
1.5.1	Dimensions of ECS-8000-PoER	12
1.5.2	Dimensions of ECS-8000-PoE	12
1.5.3	Dimensions of ECS-8000-2G	13
1.5.4	Dimensions of ECS-8000-2R	13
<b>CHAPTER 2</b>	<b>GETTING TO KNOW YOUR ECS-8000</b>	<b>14</b>
2.1	Packing List	14
2.2	Front Panel I/O Functions	14
2.3	Rear Panel I/O and Functions	22
2.4	Main Board Expansion Connectors	27
2.5	Main Board Jumper Settings	50
2.6	Ignition Control	56
<b>CHAPTER 3</b>	<b>SYSTEM SETUP</b>	<b>59</b>
3.1	How to Open Your ECS-8000	59
3.1.1	ECS-8000-PoER/ ECS-8000-2R	59
3.1.2	ECS-8000-PoE/ ECS-8000-2G	61

<b>3.2</b>	<b>Installing DDR3L SO-DIMM Modules</b>	<b>64</b>
<b>3.3</b>	<b>Installing Mini PCIe Cards</b>	<b>65</b>
<b>3.4</b>	<b>Installing Antenna Cable</b>	<b>66</b>
<b>3.5</b>	<b>Installing CFast Card and SIM Card</b>	<b>68</b>
<b>3.6</b>	<b>Installing SSD/HDD</b>	<b>70</b>
3.6.1	ECS-8000-PoER/ ECS-8000-2R	70
3.6.2	ECS-8000-PoE/ ECS-8000-2G	71
<b>3.7</b>	<b>Mounting ECS-8000</b>	<b>74</b>
<b>CHAPTER 4</b>	<b>BIOS AND DRIVER SETTING</b>	<b>75</b>
<b>4.1</b>	<b>BIOS Settings</b>	<b>75</b>
<b>4.2</b>	<b>Main Menu</b>	<b>75</b>
<b>4.3</b>	<b>Advanced Function</b>	<b>76</b>
<b>4.4</b>	<b>Chipset Function</b>	<b>83</b>
<b>4.5</b>	<b>Boot Function</b>	<b>84</b>
<b>4.6</b>	<b>Save &amp; Exit</b>	<b>85</b>
<b>APPENDIX A :</b>	<b>ISOLATED DIO GUIDE</b>	<b>86</b>
<b>APPENDIX B :</b>	<b>GPIO and WDT Functions</b>	<b>90</b>
<b>APPENDIX C :</b>	<b>Power Consumption</b>	<b>91</b>

# 1

## GENERAL INTRODUCTION

### 1.1 Overview

ECS-8000 Series Fanless Embedded System is a perfect integrated high performance embedded engine in the market. Powerful quad-core 5th generation Intel® Core™ i7 (Broadwell-H) engine running with 15% enhanced productivity than former generation, Intel® QM87 chipset, dual channel DDR3L memory at 1600MHz, up to 32GB. Advanced Intel® Iris™ Pro Graphics 6200/ Intel® HD Graphics 5600 supports DirectX 11.2, OpenGL 4.3 and OpenCL 2.0 API, onboard VGA, DVI-D, dual DisplayPort, and eDP display interface, up to 3 independent 4K Ultra HD displays.

Featured with 2 front-access 2.5" SSD/ HDD trays, 6 Gigabit LAN ports with 4 IEEE 802.3at PoE+ ports, 3 Mini PCIe sockets for PCIe/ USB/ External SIM Card/ mSATA, 2 External SIM Card sockets support 3G/ 4G/ LTE/ WiFi/ GPRS/ UMTS, 1 External CFast socket, 4 USB 3.0, 3 USB 2.0, 4 COM, 2 SATA III, 16 Isolated DIO, 6V to 36V wide range power input with up to 80V smart surge protection, 16-mode configurable ignition power control, all-in-one, cable-less, single board design, fanless design and -25°C to 70°C operating temperature, optional supports SUMIT expansion, ECS-8000 is ready to meet your project requirements.

Vecow ECS-8000 Series high performance Fanless Embedded System delivers leading performance, superb integration, intelligent manageability, smart protection functions and rugged reliability for your machine vision, intelligent control, smart manufacturing, intelligent transportation, energy management, intelligent surveillance, Industry 4.0 and any Internet of Thing (IoT) applications.



## 1.2 Features

- Quad Core 5th generation Intel® Core™ i7 Mobile Processor (Broadwell-H)
- VGA/ DVI-D/ DisplayPort/ eDP Interface, up to 3 independent 4K displays
- Fanless, -25°C to 70°C Operating Temperature
- 6 Gigabit LAN with 4 IEEE 802.3at PoE<sup>+</sup>
- 16 Isolated DIO (8 DI, 8 DO)
- 3 Mini PCIe for 3G/ 4G/ LTE/ WiFi/ GPRS/ UMTS
- 2 External SIM Card Socket
- 2 Front-access 2.5" HDD/ SSD Tray
- 4 COM RS-232/ 422/ 485, 4 USB 3.0, 3 USB 2.0
- 6V to 36V DC-in with 80V Surge Protection
- Configurable Ignition Power Control

## 1.3 Product Specification

### 1.3.1 Specifications of ECS-8000-PoER

System	
Processor	Quad Core Intel® Core™ i7-5850EQ/ i7-5700EQ (Broadwell-H)
Chipset	Intel® QM87
BIOS	AMI
SIO	IT8786E
Memory	<ul style="list-style-type: none"> <li>• DDR3L 1600 MHz SO-DIMM, up to 32GB</li> <li>• 2 204-pin SO-DIMM Socket</li> </ul>
I/O Interface	
Serial	4 COM RS-232/ 422/ 485
USB	<ul style="list-style-type: none"> <li>• 4 USB 3.0 (External)</li> <li>• 3 USB 2.0 (2 External, 1 Internal)</li> </ul>
Isolated DIO	16 Isolated DIO : 8 DI, 8 DO
LED	Power, HDD, PoE
SIM Card	2 SIM Card Socket (External)
Expansion	
Mini PCIe	3 Mini PCIe Socket : <ul style="list-style-type: none"> <li>• 2 Mini PCIe for PCIe/ USB/ External SIM Card/ mSATA</li> <li>• 1 Mini PCIe for PCIe/ USB</li> </ul>
SUMIT A, B	2 SUMIT Slot (Optional)
Graphics	
Graphics Processor	<ul style="list-style-type: none"> <li>• Intel® Iris Pro Graphics 6200 (5850EQ)</li> <li>• Intel® HD Graphics 5600 (5700EQ)</li> </ul>

Interface	<ul style="list-style-type: none"> <li>• VGA : Up to 1920 x 1200 @ 60Hz</li> <li>• DVI-D : Up to 1920 x 1080 @ 60Hz</li> <li>• DisplayPort 1 : Up to 4096 x 2304 @ 60Hz</li> <li>• DisplayPort 2 : Up to 4096 x 2304 @ 60Hz</li> <li>• eDP : Up to 4096 x 2304 @ 60Hz</li> </ul>
<b>Storage</b>	
SATA	2 SATA III (6Gbps)
mSATA	2 SATA III (Mini PCIe Type, 6Gbps)
SATA DOM	1 SATA II (3Gbps)
Storage Device	<ul style="list-style-type: none"> <li>• 1 CFast Socket, Push-in/ Push-out Ejector</li> <li>• 2 Front-access 2.5" SSD/ HDD Tray</li> </ul>
<b>Audio</b>	
Audio Codec	Realtek ALC888S-VD, 7.1 Channel HD Audio
Audio Interface	1 Mic-in, 1 Line-out
<b>Ethernet</b>	
LAN 1	Intel® I218 Gigabit LAN supports iAMT
LAN 2	Intel® I210 Gigabit LAN
<b>PoE</b>	
LAN 3	Gigabit IEEE 802.3at (25.5W/48V) PoE <sup>+</sup> by Intel® I210
LAN 4	Gigabit IEEE 802.3at (25.5W/48V) PoE <sup>+</sup> by Intel® I210
LAN 5	Gigabit IEEE 802.3at (25.5W/48V) PoE <sup>+</sup> by Intel® I210
LAN 6	Gigabit IEEE 802.3at (25.5W/48V) PoE <sup>+</sup> by Intel® I210
<b>Power</b>	
Power Input	6V to 36V, DC-in
Power Interface	<ul style="list-style-type: none"> <li>• 3-pin Terminal Block : V+, V-, IGN, Frame Ground</li> <li>• Mini-DIN 4-pin</li> </ul>
Ignition Control	16 Mode (Internal)
Remote Switch	3-pin Terminal Block : On, Off, IGN
Surge Protection	Up to 80V/1ms Transient Power
<b>Others</b>	
TPM	Optional Infineon SLB9665 supports TPM 2.0, LPC Interface
Watchdog Timer	Reset : 1 to 255 sec./min. per step
Smart Management	Wake on LAN, PXE supported
HW Monitor	Monitoring temperature, voltages. Auto throttling control when CPU overheats.
<b>Software Support</b>	
OS	Windows 8, Windows 7, Linux

<b>Mechanical</b>	
Dimensions (WxDxH)	260mm x 175mm x 79mm (10.2" x 6.9" x 3.1")
Weight	2.8 kg (6.2 lb)
Mounting	<ul style="list-style-type: none"> <li>• Wallmount by mounting bracket</li> <li>• DIN Rail Mount</li> <li>• 2U Rackmount (Optional)</li> </ul>
<b>Environment</b>	
Operating Temperature	-25°C to 70°C (-13°F to 158°F)
Storage Temperature	-40°C to 85°C (-40°F to 185°F)
Humidity	5% to 95% humidity, non-condensing
Relative Humidity	95% at 70°C
Shock	<ul style="list-style-type: none"> <li>• IEC 60068-2-27</li> <li>• SSD : 50G @ wallmount, Half-sine, 11ms</li> </ul>
Vibration	<ul style="list-style-type: none"> <li>• IEC 60068-2-64</li> <li>• SSD : 5Grms, 5Hz to 500Hz, 3 Axis</li> </ul>
EMC	CE, FCC, EN 50155, EN 50121-3-2

### 1.3.2 Specifications of ECS-8000-PoE

<b>System</b>	
Processor	Quad Core Intel® Core™ i7-5850EQ/ i7-5700EQ (Broadwell-H)
Chipset	Intel® QM87
BIOS	AMI
SIO	IT8786E
Memory	<ul style="list-style-type: none"> <li>• DDR3L 1600 MHz SO-DIMM, up to 32GB</li> <li>• 2 204-pin SO-DIMM Socket</li> </ul>
<b>I/O Interface</b>	
Serial	4 COM RS-232/ 422/ 485
USB	<ul style="list-style-type: none"> <li>• 4 USB 3.0 (External)</li> <li>• 3 USB 2.0 (2 External, 1 Internal)</li> </ul>
Isolated DIO	16 Isolated DIO : 8 DI, 8 DO
LED	Power, HDD, PoE
SIM Card	2 SIM Card Socket (External)
<b>Expansion</b>	
Mini PCIe	3 Mini PCIe Socket : <ul style="list-style-type: none"> <li>• 2 Mini PCIe for PCIe/ USB/ External SIM Card/ mSATA</li> <li>• 1 Mini PCIe for PCIe/ USB</li> </ul>
SUMIT A, B	2 SUMIT Slot (Optional)

<b>Graphics</b>	
Graphics Processor	<ul style="list-style-type: none"> <li>• Intel® Iris Pro Graphics 6200 (5850EQ)</li> <li>• Intel® HD Graphics 5600 (5700EQ)</li> </ul>
Interface	<ul style="list-style-type: none"> <li>• VGA : Up to 1920 x 1200 @ 60Hz</li> <li>• DVI-D : Up to 1920 x 1080 @ 60Hz</li> <li>• DisplayPort 1 : Up to 4096 x 2304 @ 60Hz</li> <li>• DisplayPort 2 : Up to 4096 x 2304 @ 60Hz</li> <li>• eDP : Up to 4096 x 2304 @ 60Hz</li> </ul>
<b>Storage</b>	
SATA	2 SATA III (6Gbps)
mSATA	2 SATA III (Mini PCIe Type, 6Gbps)
SATA DOM	1 SATA II (3Gbps)
Storage Device	<ul style="list-style-type: none"> <li>• 1 CFAST Slot, Push-in/ Push-out Ejector</li> <li>• 2 2.5" SSD/ HDD Bracket (Internal)</li> </ul>
<b>Audio</b>	
Audio Codec	Realtek ALC888S-VD, 7.1 Channel HD Audio
Audio Interface	1 Mic-in, 1 Line-out
<b>Ethernet</b>	
LAN 1	Intel® I218 Gigabit LAN supports iAMT
LAN 2	Intel® I210 Gigabit LAN
<b>PoE</b>	
LAN 3	Gigabit IEEE 802.3at (25.5W/48V) PoE+ by Intel® I210
LAN 4	Gigabit IEEE 802.3at (25.5W/48V) PoE+ by Intel® I210
LAN 5	Gigabit IEEE 802.3at (25.5W/48V) PoE+ by Intel® I210
LAN 6	Gigabit IEEE 802.3at (25.5W/48V) PoE+ by Intel® I210
<b>Power</b>	
Power Input	6V to 36V, DC-in
Power Interface	<ul style="list-style-type: none"> <li>• 3-pin Terminal Block : V+, V-, IGN, Frame Ground</li> <li>• Mini-DIN 4-pin</li> </ul>
Ignition Control	16 Mode (Internal)
Remote Switch	3-pin Terminal Block : On, Off, IGN
Surge Protection	Up to 80V/1ms Transient Power
<b>Others</b>	
TPM	Optional Infineon SLB9665 supports TPM 2.0, LPC Interface
Watchdog Timer	Reset : 1 to 255 sec./min. per step
Smart Management	Wake on LAN, PXE supported
HW Monitor	Monitoring temperature, voltages. Auto throttling control when CPU overheats.

<b>Software Support</b>	
OS	Windows 8, Windows 7, Linux
<b>Mechanical</b>	
Dimensions (WxDxH)	260mm x 175mm x 79mm (10.2" x 6.9" x 3.1")
Weight	2.8 kg (6.2 lb)
Mounting	<ul style="list-style-type: none"> <li>• Wallmount by mounting bracket</li> <li>• DIN Rail Mount</li> <li>• 2U Rackmount (Optional)</li> </ul>
<b>Environment</b>	
Operating Temperature	-25°C to 70°C (-13°F to 158°F)
Storage Temperature	-40°C to 85°C (-40°F to 185°F)
Humidity	5% to 95% humidity, non-condensing
Relative Humidity	95% at 70°C
Shock	<ul style="list-style-type: none"> <li>• IEC 60068-2-27</li> <li>• SSD : 50G @ wallmount, Half-sine, 11ms</li> </ul>
Vibration	<ul style="list-style-type: none"> <li>• IEC 60068-2-64</li> <li>• SSD : 5Grms, 5Hz to 500Hz, 3 Axis</li> </ul>
EMC	CE, FCC, EN 50155, EN 50121-3-2

### 1.3.3 Specifications of ECS-8000-2G

<b>System</b>	
Processor	Quad Core Intel® Core™ i7-5850EQ/ i7-5700EQ (Broadwell-H)
Chipset	Intel® QM87
BIOS	AMI
SIO	IT8786E
Memory	<ul style="list-style-type: none"> <li>• DDR3L 1600 MHz SO-DIMM, up to 32GB</li> <li>• 2 204-pin SO-DIMM Socket</li> </ul>
<b>I/O Interface</b>	
Serial	4 COM RS-232/ 422/ 485
USB	<ul style="list-style-type: none"> <li>• 4 USB 3.0 (External)</li> <li>• 3 USB 2.0 (2 External, 1 Internal)</li> </ul>
Isolated DIO	16 Isolated DIO : 8 DI, 8 DO
LED	Power, HDD, PoE
SIM Card	2 SIM Card Socket (External)

<b>Expansion</b>	
Mini PCIe	3 Mini PCIe Socket : <ul style="list-style-type: none"> <li>• 2 Mini PCIe for PCIe/ USB/ External SIM Card/ mSATA</li> <li>• 1 Mini PCIe for PCIe/ USB</li> </ul>
SUMIT A, B	2 SUMIT Slot (Optional)
<b>Graphics</b>	
Graphics Processor	<ul style="list-style-type: none"> <li>• Intel® Iris Pro Graphics 6200 (5850EQ)</li> <li>• Intel® HD Graphics 5600 (5700EQ)</li> </ul>
Interface	<ul style="list-style-type: none"> <li>• VGA : Up to 1920 x 1200 @ 60Hz</li> <li>• DVI-D : Up to 1920 x 1080 @ 60Hz</li> <li>• DisplayPort 1 : Up to 4096 x 2304 @ 60Hz</li> <li>• DisplayPort 2 : Up to 4096 x 2304 @ 60Hz</li> <li>• eDP : Up to 4096 x 2304 @ 60Hz</li> </ul>
<b>Storage</b>	
SATA	2 SATA III (6Gbps)
mSATA	2 SATA III (Mini PCIe Type, 6Gbps)
SATA DOM	1 SATA II (3Gbps)
Storage Device	<ul style="list-style-type: none"> <li>• 1 CFast Slot, Push-in/ Push-out Ejector</li> <li>• 2 2.5" SSD/ HDD Bracket (Internal)</li> </ul>
<b>Audio</b>	
Audio Codec	Realtek ALC888S-VD, 7.1 Channel HD Audio
Audio Interface	1 Mic-in, 1 Line-out
<b>Ethernet</b>	
LAN 1	Intel® I218 Gigabit LAN supports iAMT
LAN 2	Intel® I210 Gigabit LAN
<b>Power</b>	
Power Input	6V to 36V, DC-in
Power Interface	<ul style="list-style-type: none"> <li>• 3-pin Terminal Block : V+, V-, IGN, Frame Ground</li> <li>• Mini-DIN 4-pin</li> </ul>
Ignition Control	16 Mode (Internal)
Remote Switch	3-pin Terminal Block : On, Off, IGN
Surge Protection	Up to 80V/1ms Transient Power
<b>Others</b>	
TPM	Optional Infineon SLB9665 supports TPM 2.0, LPC Interface
Watchdog Timer	Reset : 1 to 255 sec./min. per step
Smart Management	Wake on LAN, PXE supported
HW Monitor	Monitoring temperature, voltages. Auto throttling control when CPU overheats.

<b>Software Support</b>	
OS	Windows 8, Windows 7, Linux
<b>Mechanical</b>	
Dimensions (WxDxH)	260mm x 175mm x 79mm (10.2" x 6.9" x 3.1")
Weight	2.8 kg (6.2 lb)
Mounting	<ul style="list-style-type: none"> <li>• Wallmount by mounting bracket</li> <li>• DIN Rail Mount</li> <li>• 2U Rackmount (Optional)</li> </ul>
<b>Environment</b>	
Operating Temperature	-25°C to 70°C (-13°F to 158°F)
Storage Temperature	-40°C to 85°C (-40°F to 185°F)
Humidity	5% to 95% humidity, non-condensing
Relative Humidity	95% at 70°C
Shock	<ul style="list-style-type: none"> <li>• IEC 60068-2-27</li> <li>• SSD : 50G @ wallmount, Half-sine, 11ms</li> </ul>
Vibration	<ul style="list-style-type: none"> <li>• IEC 60068-2-64</li> <li>• SSD : 5Grms, 5Hz to 500Hz, 3 Axis</li> </ul>
EMC	CE, FCC, EN 50155, EN 50121-3-2
<b>Software Support</b>	
OS	Windows 8, Windows 7, Linux
<b>Mechanical</b>	
Dimensions (WxDxH)	260mm x 175mm x 79mm (10.2" x 6.9" x 3.1")
Weight	2.8 kg (6.2 lb)
Mounting	<ul style="list-style-type: none"> <li>• Wallmount by mounting bracket</li> <li>• DIN Rail Mount</li> <li>• 2U Rackmount (Optional)</li> </ul>
<b>Environment</b>	
Operating Temperature	-25°C to 70°C (-13°F to 158°F)
Storage Temperature	-40°C to 85°C (-40°F to 185°F)
Humidity	5% to 95% humidity, non-condensing
Relative Humidity	95% at 70°C
Shock	<ul style="list-style-type: none"> <li>• IEC 60068-2-27</li> <li>• SSD : 50G @ wallmount, Half-sine, 11ms</li> </ul>
Vibration	<ul style="list-style-type: none"> <li>• IEC 60068-2-64</li> <li>• SSD : 5Grms, 5Hz to 500Hz, 3 Axis</li> </ul>
EMC	CE, FCC, EN 50155, EN 50121-3-2

### 1.3.4 Specifications of ECS-8000-2R

<b>System</b>	
Processor	Quad Core Intel® Core™ i7-5850EQ/ i7-5700EQ (Broadwell-H)
Chipset	Intel® QM87
BIOS	AMI
SIO	IT8786E
Memory	<ul style="list-style-type: none"> <li>• DDR3L 1600 MHz SO-DIMM, up to 32GB</li> <li>• 2 204-pin SO-DIMM Socket</li> </ul>
<b>I/O Interface</b>	
Serial	4 COM RS-232/ 422/ 485
USB	<ul style="list-style-type: none"> <li>• 4 USB 3.0 (External)</li> <li>• 3 USB 2.0 (2 External, 1 Internal)</li> </ul>
Isolated DIO	16 Isolated DIO : 8 DI, 8 DO
LED	Power, HDD, PoE
SIM Card	2 SIM Card Socket (External)
<b>Expansion</b>	
Mini PCIe	3 Mini PCIe Socket : <ul style="list-style-type: none"> <li>• 2 Mini PCIe for PCIe/ USB/ External SIM Card/ mSATA</li> <li>• 1 Mini PCIe for PCIe/ USB</li> </ul>
SUMIT A, B	2 SUMIT Slot (Optional)
<b>Graphics</b>	
Graphics Processor	<ul style="list-style-type: none"> <li>• Intel® Iris Pro Graphics 6200 (5850EQ)</li> <li>• Intel® HD Graphics 5600 (5700EQ)</li> </ul>
Interface	<ul style="list-style-type: none"> <li>• VGA : Up to 1920 x 1200 @ 60Hz</li> <li>• DVI-D : Up to 1920 x 1080 @ 60Hz</li> <li>• DisplayPort 1 : Up to 4096 x 2304 @ 60Hz</li> <li>• DisplayPort 2 : Up to 4096 x 2304 @ 60Hz</li> <li>• eDP : Up to 4096 x 2304 @ 60Hz</li> </ul>
<b>Storage</b>	
SATA	2 SATA III (6Gbps)
mSATA	2 SATA III (Mini PCIe Type, 6Gbps)
SATA DOM	1 SATA II (3Gbps)
Storage Device	<ul style="list-style-type: none"> <li>• 1 CFast Socket, Push-in/ Push-out Ejector</li> <li>• 2 Front-access 2.5" SSD/ HDD Tray</li> </ul>
<b>Audio</b>	
Audio Codec	Realtek ALC888S-VD, 7.1 Channel HD Audio
Audio Interface	1 Mic-in, 1 Line-out



<b>Ethernet</b>	
LAN 1	Intel® I218 Gigabit LAN supports iAMT
LAN 2	Intel® I210 Gigabit LAN
<b>Power</b>	
Power Input	6V to 36V, DC-in
Power Interface	<ul style="list-style-type: none"> <li>• 3-pin Terminal Block : V+, V-, IGN, Frame Ground</li> <li>• Mini-DIN 4-pin</li> </ul>
Ignition Control	16 Mode (Internal)
Remote Switch	3-pin Terminal Block : On, Off, IGN
Surge Protection	Up to 80V/1ms Transient Power
<b>Others</b>	
TPM	Optional Infineon SLB9665 supports TPM 2.0, LPC Interface
Watchdog Timer	Reset : 1 to 255 sec./min. per step
Smart Management	Wake on LAN, PXE supported
HW Monitor	Monitoring temperature, voltages. Auto throttling control when CPU overheats.
<b>Software Support</b>	
OS	Windows 8, Windows 7, Linux
<b>Mechanical</b>	
Dimensions (WxDxH)	260mm x 175mm x 79mm (10.2" x 6.9" x 3.1")
Weight	2.8 kg (6.2 lb)
Mounting	<ul style="list-style-type: none"> <li>• Wallmount by mounting bracket</li> <li>• DIN Rail Mount</li> <li>• 2U Rackmount (Optional)</li> </ul>
<b>Environment</b>	
Operating Temperature	-25°C to 70°C (-13°F to 158°F)
Storage Temperature	-40°C to 85°C (-40°F to 185°F)
Humidity	5% to 95% humidity, non-condensing
Relative Humidity	95% at 70°C
Shock	<ul style="list-style-type: none"> <li>• IEC 60068-2-27</li> <li>• SSD : 50G @ wallmount, Half-sine, 11ms</li> </ul>
Vibration	<ul style="list-style-type: none"> <li>• IEC 60068-2-64</li> <li>• SSD : 5Grms, 5Hz to 500Hz, 3 Axis</li> </ul>
EMC	CE, FCC, EN 50155, EN 50121-3-2

## 1.4 Supported CPU List

CPU Name	TDP	Cache	Max. Frequency	Embedded
i7-5950HQ	47 W	6MB	Up to 3.80 GHz	
i7-5850HQ	47 W	6MB	Up to 3.60 GHz	
<b>i7-5850EQ</b>	<b>47 W</b>	<b>6MB</b>	<b>Up to 3.40 GHz</b>	<b>Yes</b>
i7-5750HQ	47 W	6MB	Up to 3.50 GHz	
i7-5700HQ	47 W	6MB	Up to 3.50 GHz	
<b>i5-5700EQ</b>	<b>47 W</b>	<b>6MB</b>	<b>Up to 3.40 GHz</b>	<b>Yes</b>

# 1.5 Mechanical Dimensions

## 1.5.1 Dimensions of ECS-8000-PoER

Unit: mm (inch)

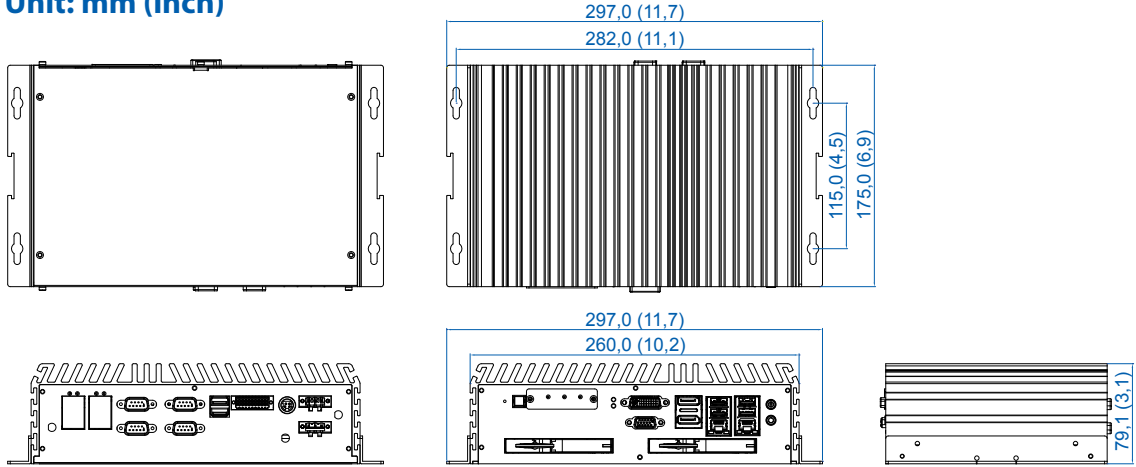

## 1.5.2 Dimensions of ECS-8000-PoE

Unit: mm (inch)

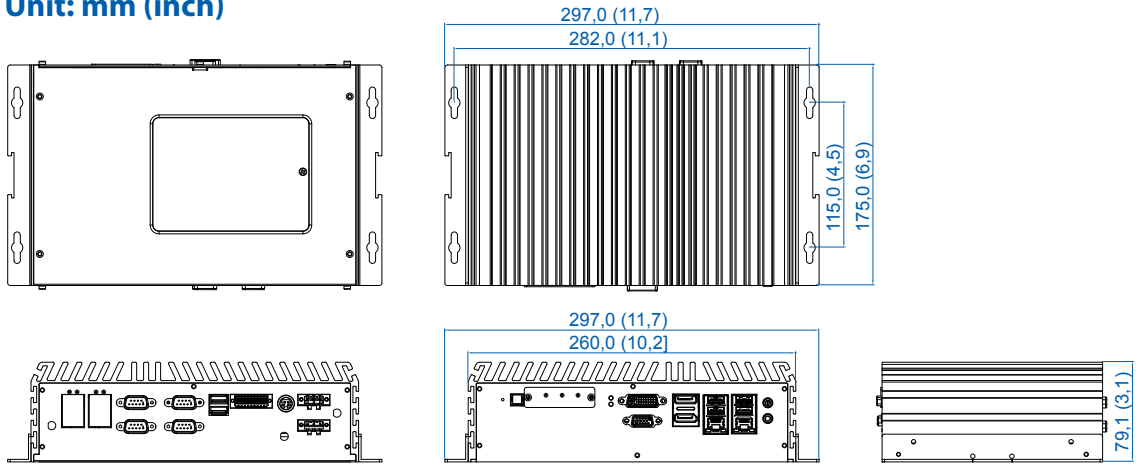

### 1.5.3 Dimensions of ECS-8000-2G

Unit: mm (inch)

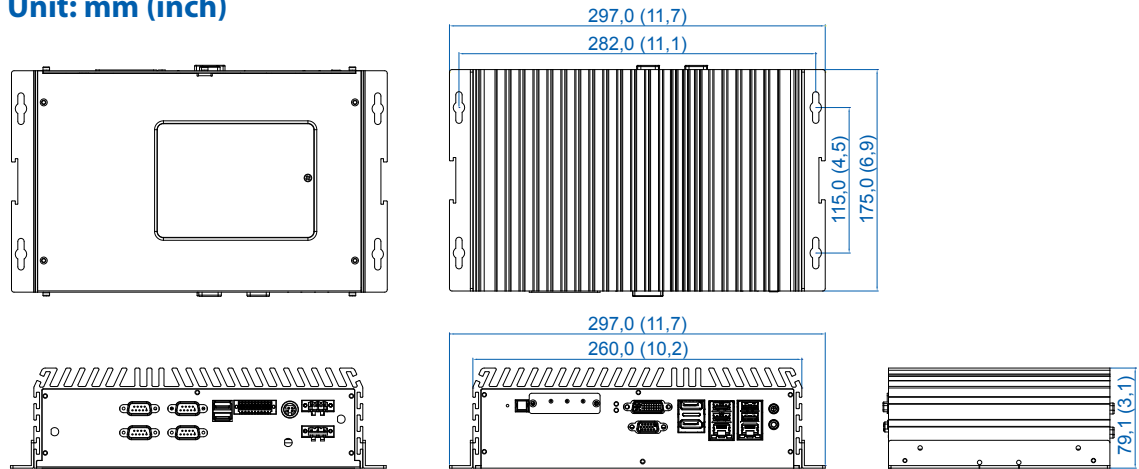

### 1.5.4 Dimensions of ECS-8000-2R

Unit: mm (inch)

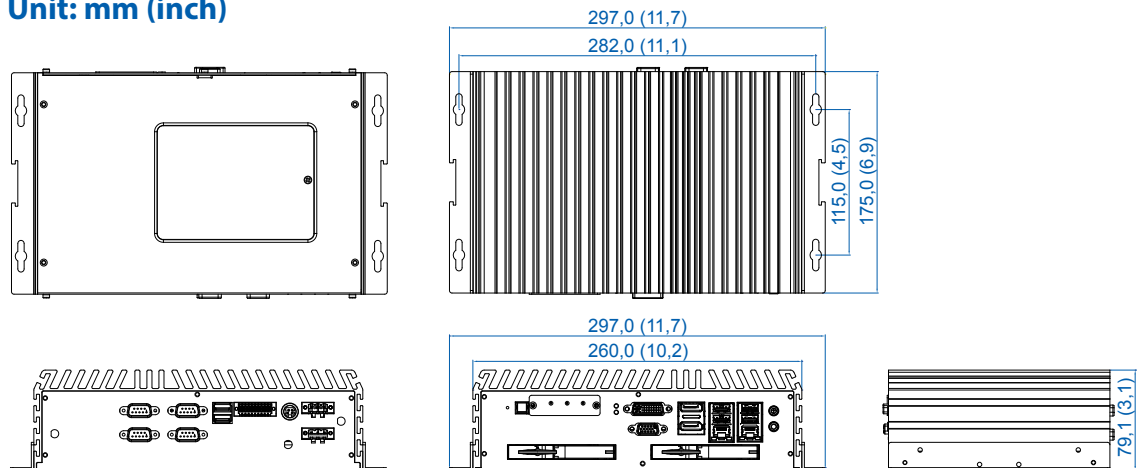

# 2

## GETTING TO KNOW YOUR ECS-8000

### 2.1 Packing List

Item	Description	Qty
1	ECS-8000 Fanless Embedded System (According to the configuration you order, the ECS-8000 series may contain SSD/HDD and DDR3L SO-DIMM. Please verify these items if necessary.)	1
2	Accessory box, which contains <ul style="list-style-type: none"><li>• Vecow Drivers &amp; Utilities DVD</li><li>• Wall-mounting bracket</li><li>• KHS#6-32x6 screw for wall-mounting bracket</li><li>• M2.5x6 screw for Mini PCIe Slot</li><li>• 3-pin Pluggable terminal block</li><li>• 20-pin pluggable terminal block</li><li>• Foot Pad</li><li>• HDD Tray Key</li></ul>	1 2 4 6 2 1 4 2

### 2.2 Front Panel I/O Functions

In Vecow ECS-8000 series family, all I/O connectors are located on front panel and rear panel. Most of the general connections to computer device, such as USB, DVI-D, DisplayPort and any additional storage, are placed on the front panel.

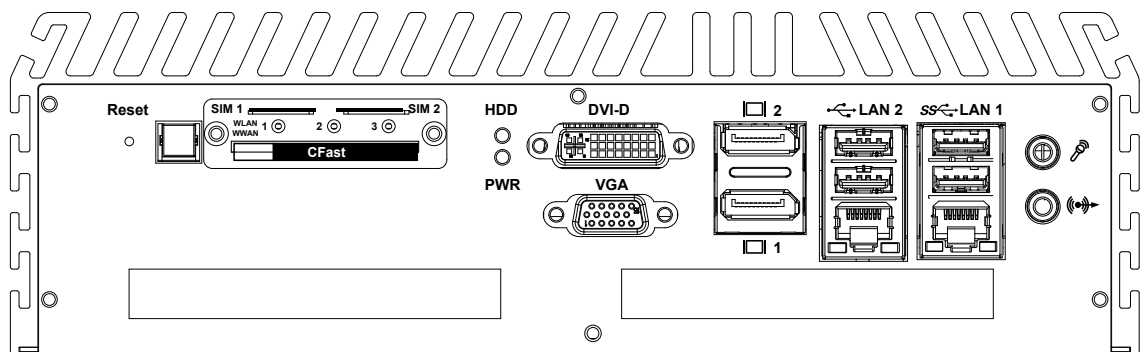

## 2.2.1 Reset Tact Switch

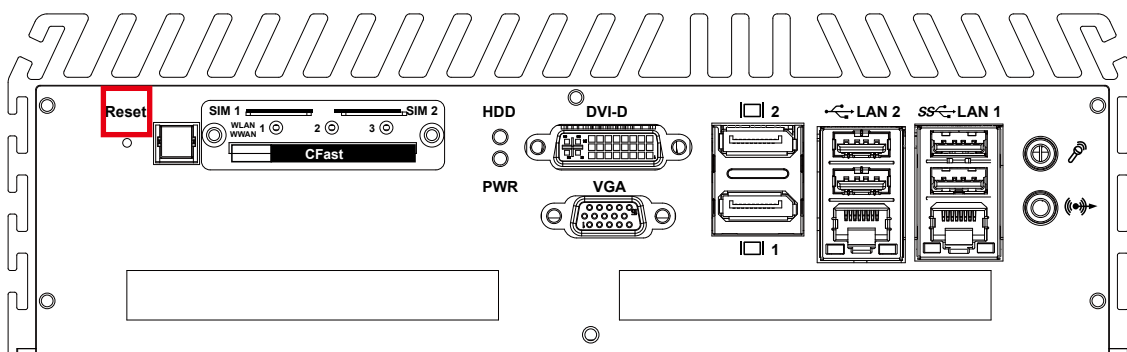

It is a hardware reset switch. Use this switch to reset the system without power off the ECS-8000. Press the Reset Switch for a few seconds, then reset will be enabled.

## 2.2.2 Power Button

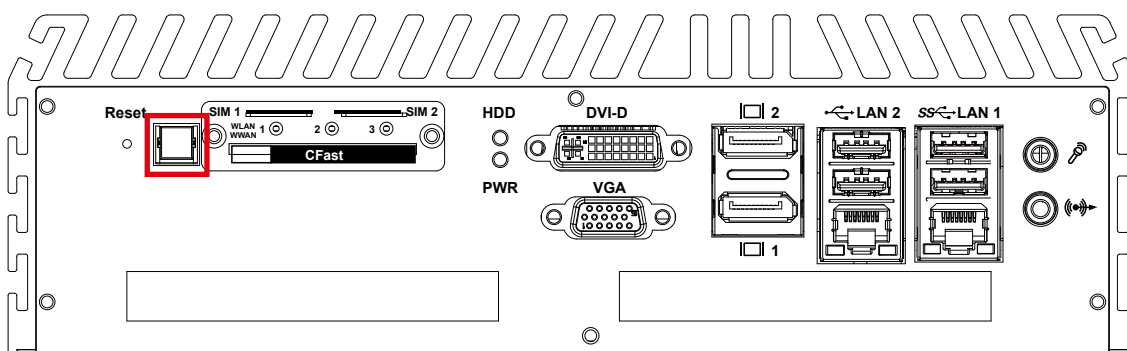

The Power Button is a non-latched switch with dual color LED indication. It indicates power status: S0, S3 and S5. More detail LED indications are listed as follows:

LED Color	Power Status	System Status
Solid Blue	S0	System working
Solid Orange	S3, S5	Suspend to RAM, System off with standby power

To power on ECS-8000, press the power button and then the blue LED is lightened. To power off ECS-8000, you can either command shutdown by OS operation, or just simply press the power button. If system error, you can just press the power button for 4 seconds to shut down the machine directly.

Please do note that a 4-second interval between each 2 power-on/ power-off operation is necessary in normal working status. (For example, once turning off the system, you have to wait for 4 seconds to initiate another power-on operation).

## 2.2.3 CFast Card

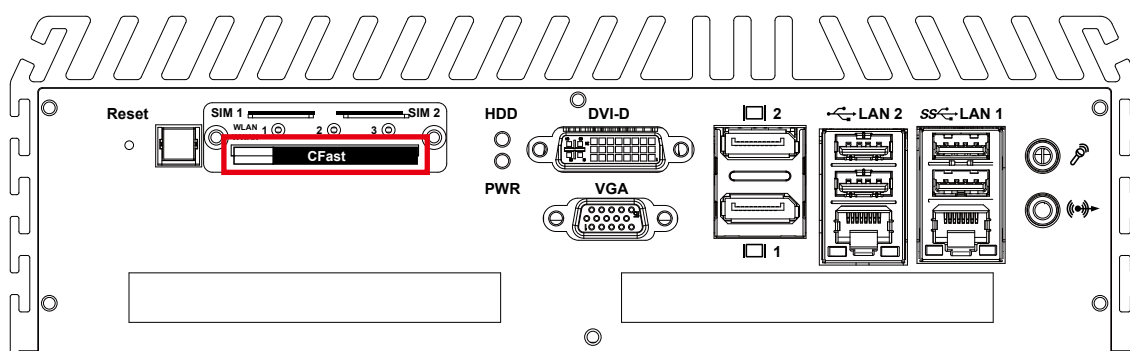

There is a CFast socket on the front panel supporting Type-I/ Type-II Compact Flash card.

It is implemented by a SATA II Port from Broadwell-H PCH. Be sure to disconnect the power source and unscrew the CFast socket cover before installing a CFast card. The ECS-8000 does not support the CFast hot swap and PnP (Plug and Play) functions. It is necessary to remove power source first before inserting or removing the CFast card.

The pinouts of CFast port are listed as follows:

Pin No.	Description	Pin No.	Description
S1	GND	PC6	NC
S2	SATA_TXP	PC7	GND
S3	SATA_TXN	PC8	CFAST_LED
S4	GND	PC9	NC
S5	SATA_RXN	PC10	NC
S6	SATA_RXP	PC11	NC
S7	GND	PC12	NC
PC1	GND	PC13	+3.3V
PC2	GND	PC14	+3.3V
PC3	NC	PC15	GND
PC4	NC	PC16	GND
PC5	NC	PC17	NC

## 2.2.4 PWR and HDD LED Indicator

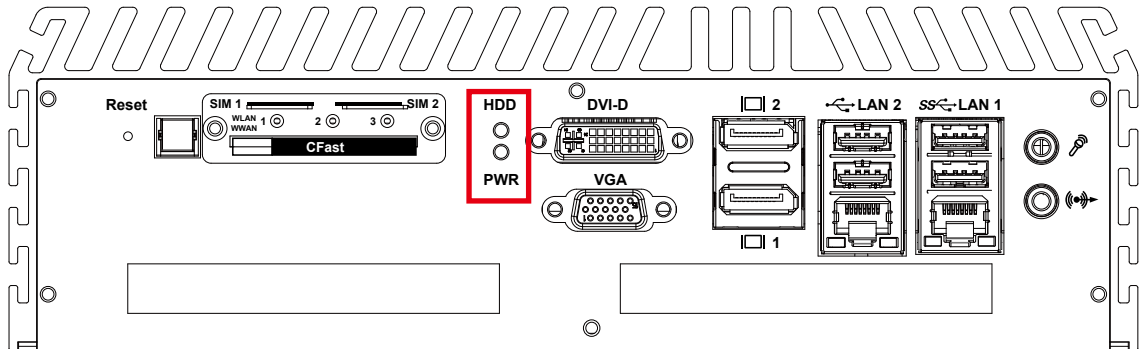

**Yellow-HDD LED:** A hard disk/ CFast LED. If the LED is on, it indicates that the system's storage is functional. If it is off, it indicates that the system's storage is not functional. If it is flashing, it indicates data access activities.

**Green-Power LED:** If the LED is solid green, it indicates that the system is powered on.

LED Color	Power Status	System Status
Yellow	HDD/ CFast	<ul style="list-style-type: none"> <li>On/ Off : Storage status, function or not.</li> <li>Twinkling : Data transferring.</li> </ul>
Green	Power	System power status (on/ off)

## 2.2.5 DVI-D Connector

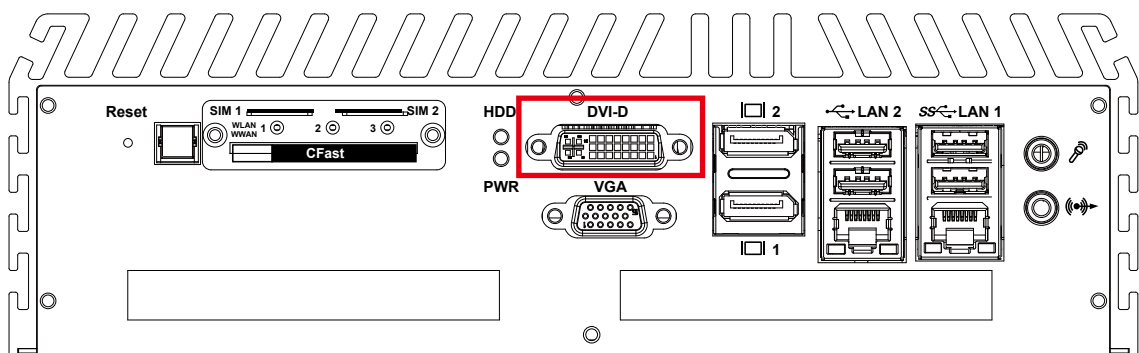

The DVI-D connector on the front panel supports DVI display modes. The DVI output mode supports up to 1920 x 1080 resolutions.



## 2.2.6 VGA Connector

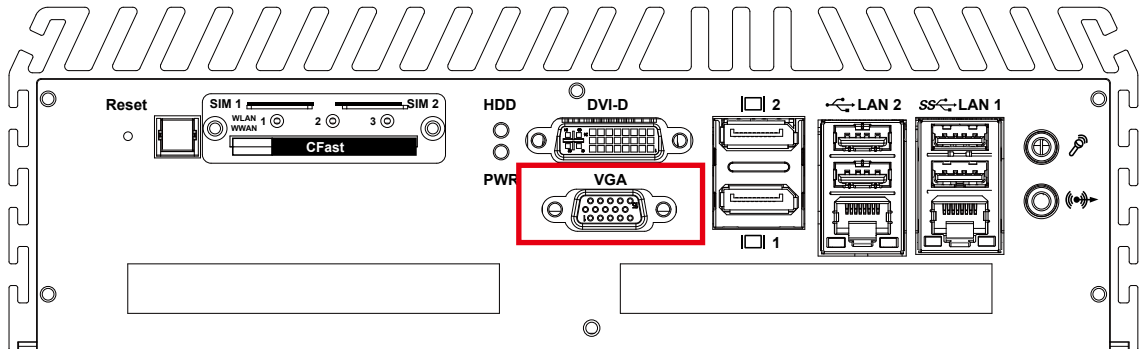

The VGA output mode supports up to 1920x1200 resolution. The pin assignments of the VGA connector are shown below.

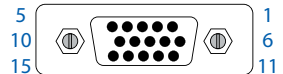

Pin No.	Description	Pin No.	Description
1	Red Color Signal	9	VCC
2	Green Color Signal	10	Ground
3	Blue Color Signal	11	NC
4	NC	12	DDC-DATA
5	Ground	13	H-Sync.
6	VGA Detect	14	V-Sync.
7	Ground	15	DDC-CLK
8	Ground		

## 2.2.7 DisplayPort

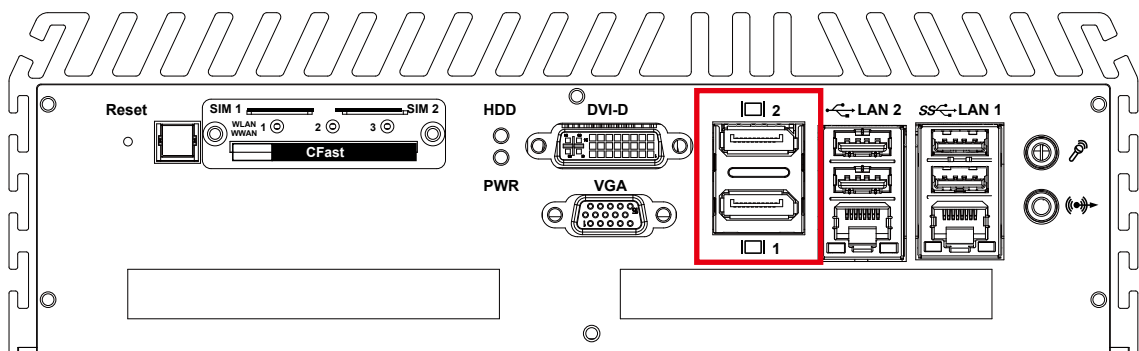

Onboard DisplayPort connection supports up to 4096 x 2304 resolutions at 60 Hz.

## 2.2.8 External USB

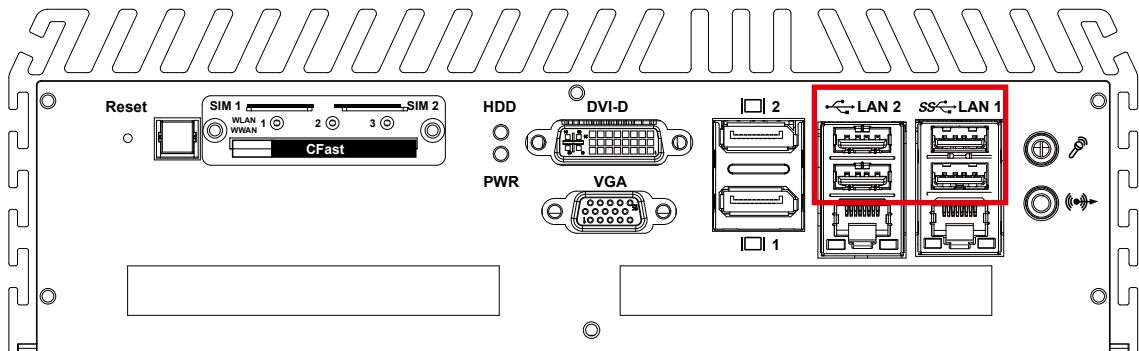

There are 2 USB 3.0 connections available supporting up to 5GB per second data rate in the front side of ECS-8000. It also compliant with the requirements of SuperSpeed (SS), high speed (HS), full speed (FS) and low speed (LS).

## 2.2.9 Wireless LED Indicator, Mini PCIe & SIM card

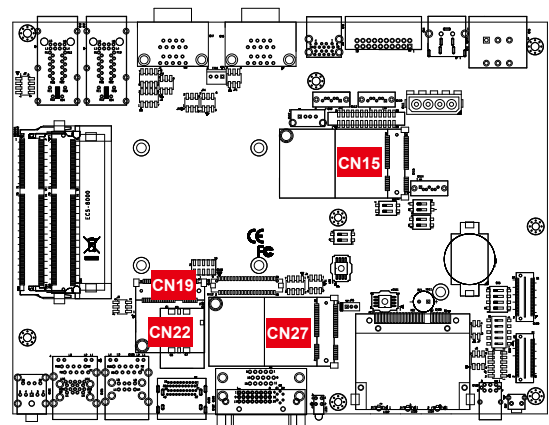
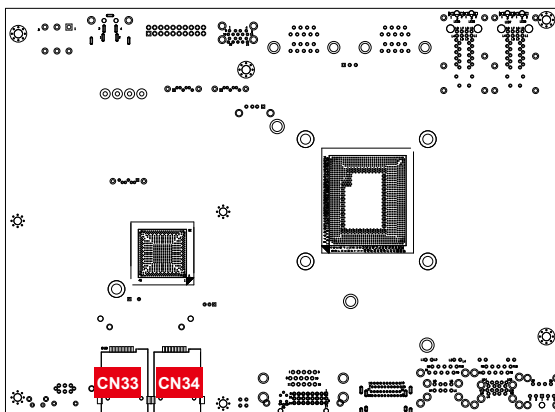
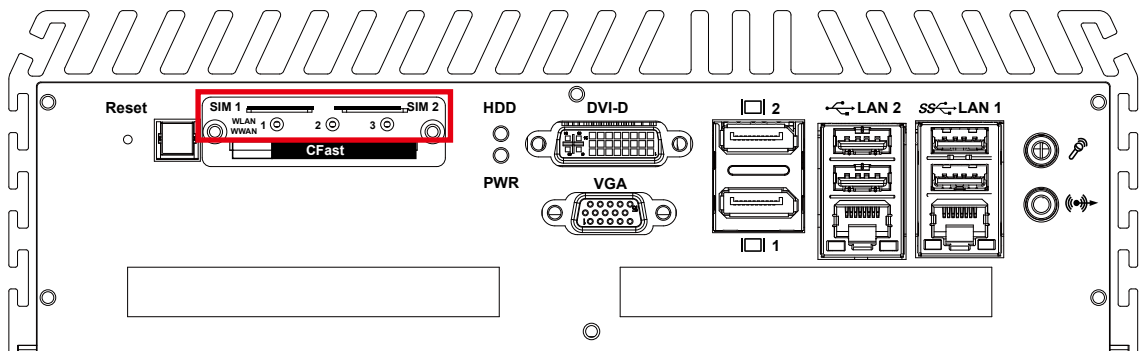

Mini PCIe	SIM	LED
CN27	CN33 (SIM 1)	1
CN15	CN34 (SIM 2)	2
CN19	CN22 (SIM3)	3

Note:

The SIM card sockets do not support hot-plug. Please make sure to unplug the system power before inserting the SIM card(s).

## 2.2.10 10/ 100/ 1000 Mbps Ethernet Port

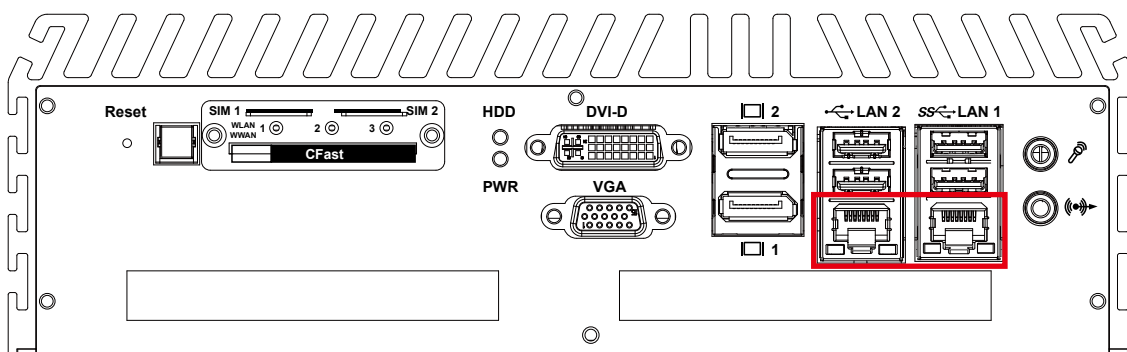

There are 2 8-pin RJ-45 jacks supporting 10/ 100/1000 Mbps Ethernet connections in the front side and rear side of ECS-8000. LAN 1 is powered by Intel® I218LM Ethernet engine; LAN 2 is powered by Intel I210 Ethernet engine. When both LAN 1 and LAN 2 work in normal status, basic iAMT function is enabled. Using suitable RJ-45 cable, you can connect ECS-8000 system to a computer, or to any other devices with Ethernet connection, for example, a hub or a switch. Moreover, both of LAN 1 and LAN 2 supports Wake on LAN and Pre-boot functions. The pinouts of LAN 1 and LAN 2 are listed as follows:

Pin No.	10/ 100Mbps	1000Mbps
1	E_TX+	MDI0_P
2	E_TX-	MDI0_N
3	E_RX+	MDI1_P
4	----	MDI2_P
5	----	MDI2_N
6	E_RX-	MDI1_N
7	----	MDI3_P
8	-----	MDI3_N

Each LAN port is supported by standard RJ-45 connector with LED indicators to present Active/ Link/ Speed status of the connection. The LED indicator on the right bottom corner lightens in solid green when the cable is properly connected to a 100Mbps Ethernet network; The LED indicator on the right bottom corner lightens in solid orange when the cable is properly connected to a 1000Mbps Ethernet network; The left LED will keep twinkling/ off when Ethernet data packets are being transmitted/ received.

LED	10Mbps	100Mbps	1000Mbps
Right Bottom Led	Off	Solid Green	Solid Orange
Left Bottom Led	Twinkling Yellow	Twinkling Yellow	Twinkling Yellow

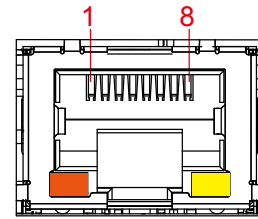

### 2.2.11 Audio Connector

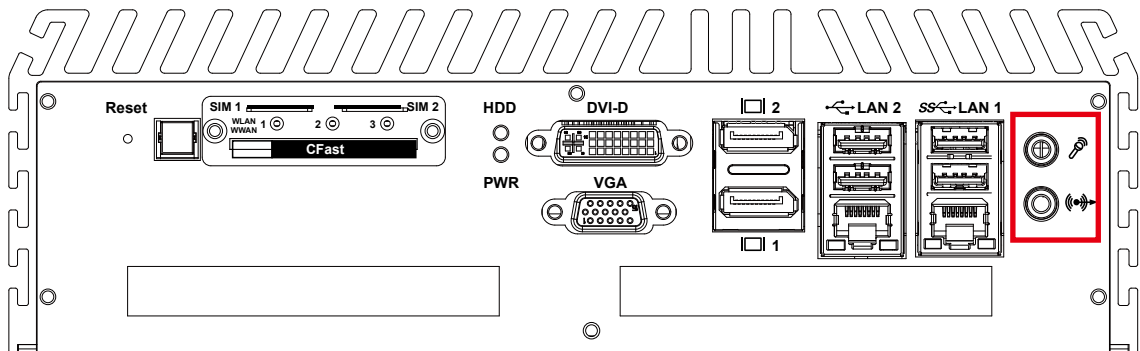

There are 2 audio connectors, Mic-in and Line-out, in the front side of ECS-8000. Onboard Realtek ALC888S-VD audio codec supports 7.1 channel HD audio and fully complies with Intel® High Definition Audio (Azalia) specifications.

To utilize the audio function in Windows platform, you need to install corresponding drivers for both Intel Broadwell-H chipset and Realtek ALC888S-VD codec.

### 2.2.12 Front-access SSD/ HDD Tray

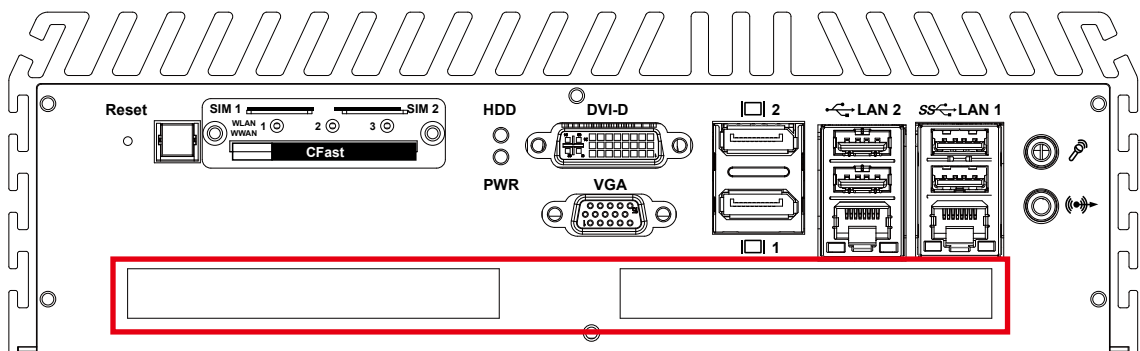

There are 2 front-access 2.5" SSD/ HDD trays in the front side of ECS-8000. Just trigger to open the SSD/ HDD tray, up to 4TB is available.

## 2.3 Rear Panel I/O and Functions

### 2.3.1 Power Terminal Block

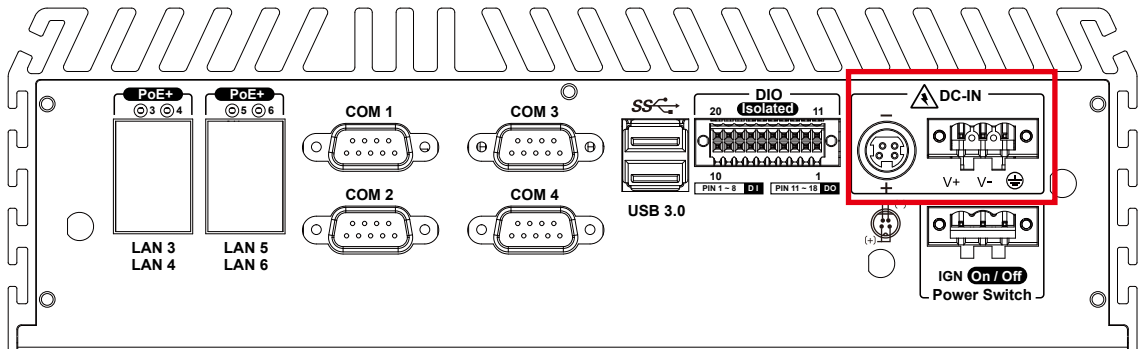

ECS-8000 supports 6V to 36V DC power input by terminal block in the rear side. In normal power operation, power LED lightens in solid green. ECS-8000 supports up to 80V surge protection.

Pin No.	Definition
1	V+
2	V-
3	Earth GND

### 2.3.2 Remote Power On/ Off Switch

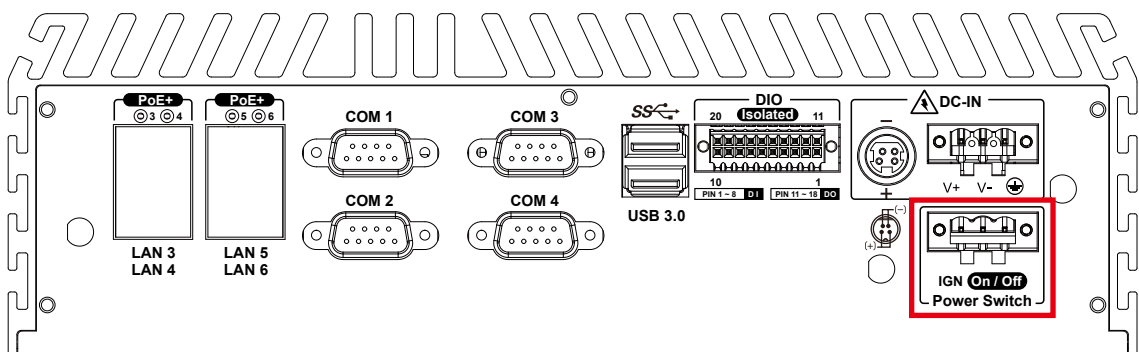

It is a 2-pin power-on or power-off switch through Phoenix Contact terminal block. You could turn on or off the system power by using this contact. This terminal block supports dual function of soft power-on/ power-off (instant off or delay 4 second), and suspend mode.



Pin No.	Definition
1	IGNITION
2	SW+
3	SW-

### 2.3.3 Isolated DIO

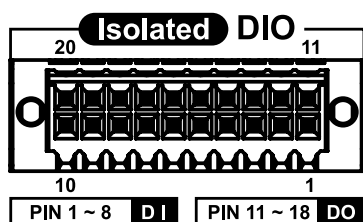
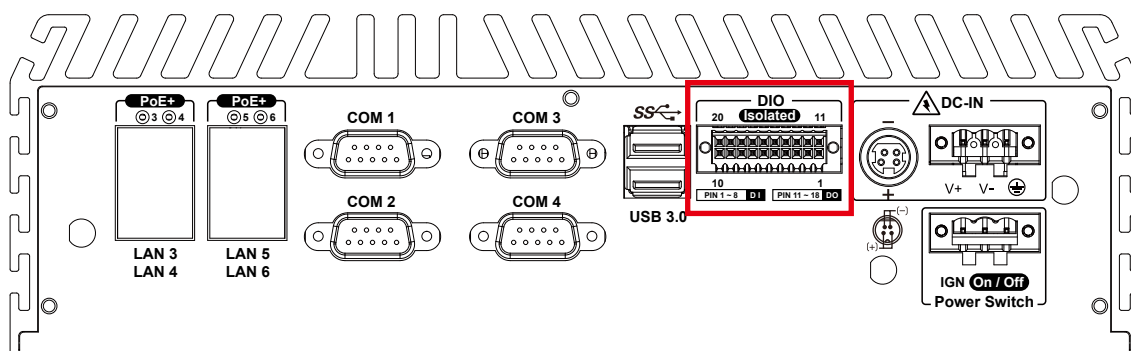

There is a 16-bit DIO (8-bit DI, 8-bit DO) connector in the rear side. Each DIO channel is equipped with a photocoupler for isolated protection. A power buffer device TPD2007F integrated in 8-DO circuit for motors, solenoids, and lamp driver applications. Please refer to [Appendix A](#) for more details.

Pin No.	Definition	Pin No.	Definition
1	INPUT 0	11	OUTPUT 0
2	INPUT 1	12	OUTPUT 1
3	INPUT 2	13	OUTPUT 2
4	INPUT 3	14	OUTPUT 3
5	INPUT 4	15	OUTPUT 4
6	INPUT 5	16	OUTPUT 5
7	INPUT 6	17	OUTPUT 6
8	INPUT 7	18	OUTPUT 7
9	DI_COM	19	DIO_GND
10	DIO_GND	20	External 24~78VDC Input

### GPI SINK Mode

Isolated GPI input circuit in SINK mode (NPN) is illustrated as follow :

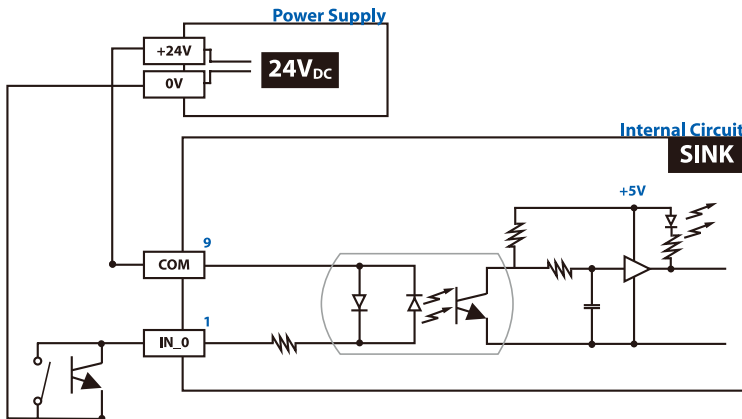

### GPI SOURCE Mode

Digital GPI input signal circuit in SOURCE mode (PNP) is illustrated as follow :

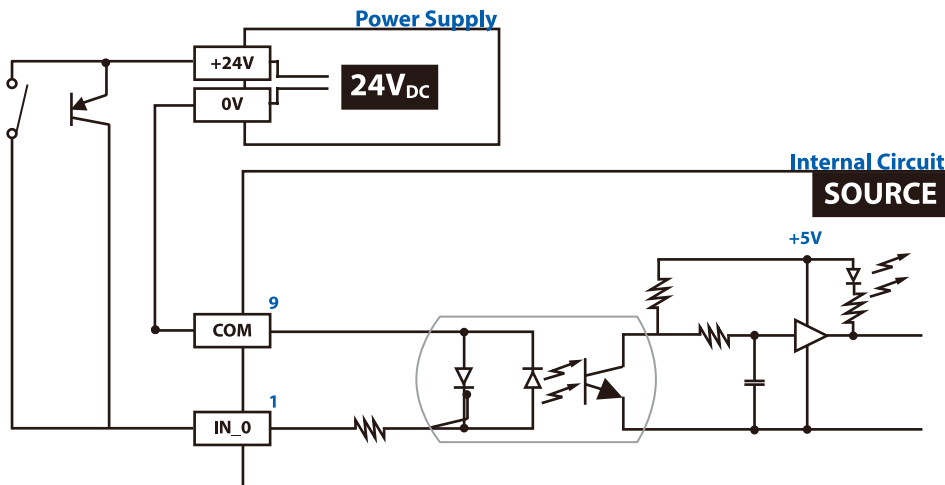

### GPO SINK Mode

Digital GPO output circuit in SINK mode (NPN) is illustrated as follow :

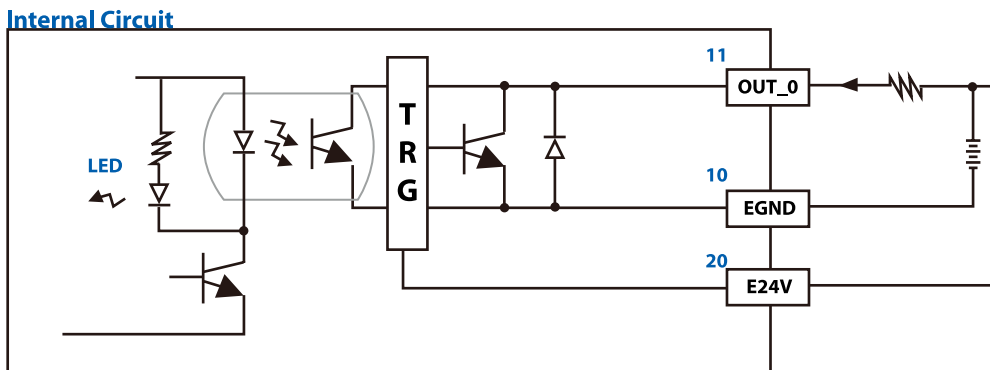

### 2.3.4 Serial Port COM

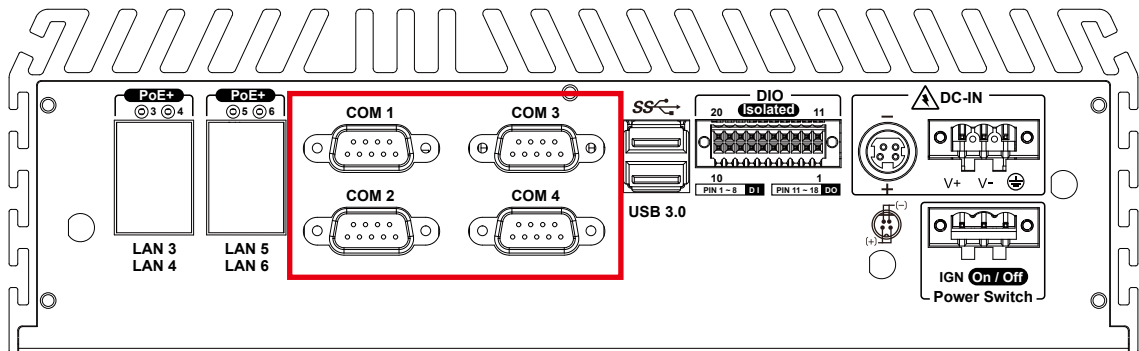

Serial port can be configured for RS-232, RS-422, or RS-485 with auto flow control communication. The default definition is RS-232, if you want to change to RS-422 or RS-485, you can find the setting in BIOS.

BIOS Setting	Function
COM 1 (CN7) / COM 2 (CN8) / COM 3 (CN11) / COM 4 (CN12)	RS-232
	RS-422 (5-wire)
	RS-422 (9-wire)
	RS-485
	RS-485 w/z auto-flow control

The pin assignments are listed in the table as follow :

Serial Port	Pin No.	RS-232	RS-422 (5-wire)	RS-422 (9-wire)	RS-485 (3-wire)
1, 2 3, 4	1	DCD	TXD-	TXD-	DATA-
	2	RXD	TXD+	TXD+	DATA+
	3	TXD	RXD+	RXD+	-----
	4	DTR	RXD-	RXD-	-----
	5	GND	GND	GND	GND
	6	DSR	-----	RTS-	-----
	7	RTS	-----	RTS+	-----
	8	CTS	-----	CTS+	-----
	9	RI	-----	CTS-	-----



### 2.3.5 PoE (Power over Ethernet) Ports

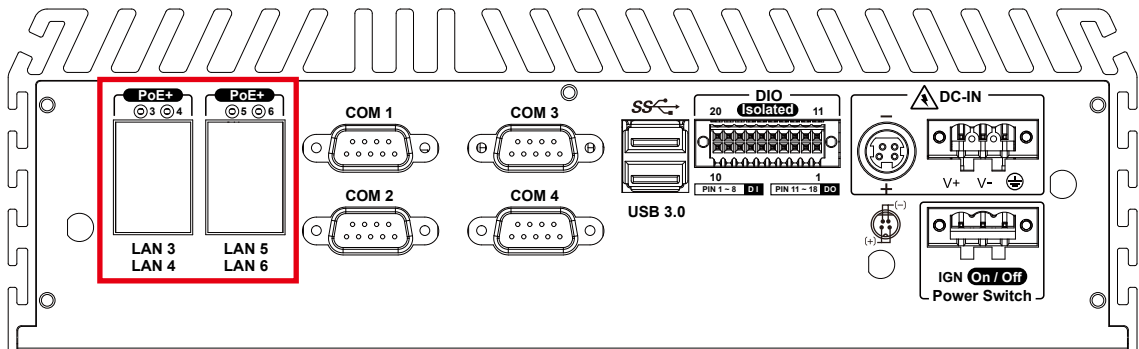

There are 4 RJ45 connectors in the rear side of ECS-8000. It supports IEEE 802.3at (PoE<sup>+</sup>) Power over Ethernet (PoE) connection delivering up to 25.5W/ 48V per port and 1000BASE-T gigabit data signals over standard Ethernet Cat 5/ Cat 6 cable.

Each PoE connection is powered by Intel<sup>®</sup> I210 Gigabit Ethernet controller and independent PCI express interface to connect with multi-core processor for network and data transmit optimization. Only when PoE port starts to supply power to power devices, the dedicated LED will be lightened.

PS. Suggest to use PoE when power input is over 11V

### 2.3.6 External USB

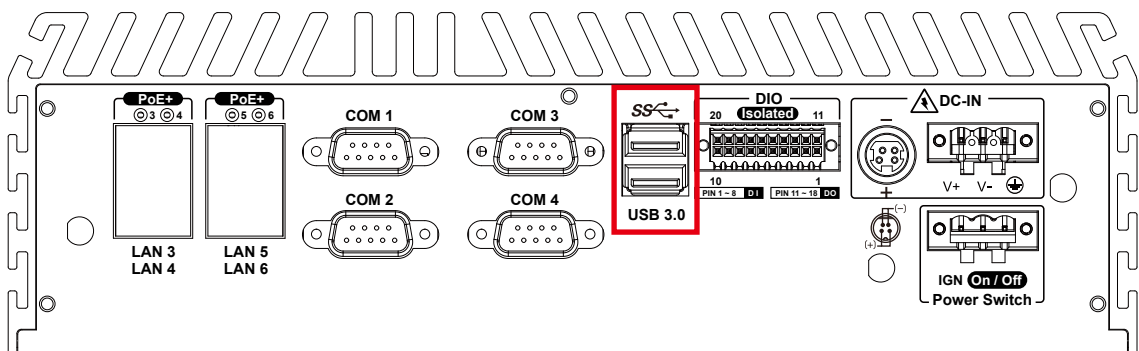

There are 2 USB 3.0 connections available supporting up to 5GB per second data rate in the front side of ECS-8000. It also compliant with the requirements of SuperSpeed (SS), high speed (HS), full speed (FS) and low speed (LS).

## 2.4 Main Board Expansion Connectors

### 2.4.1 Top View of ECS-8000 Main Board With Connector Location

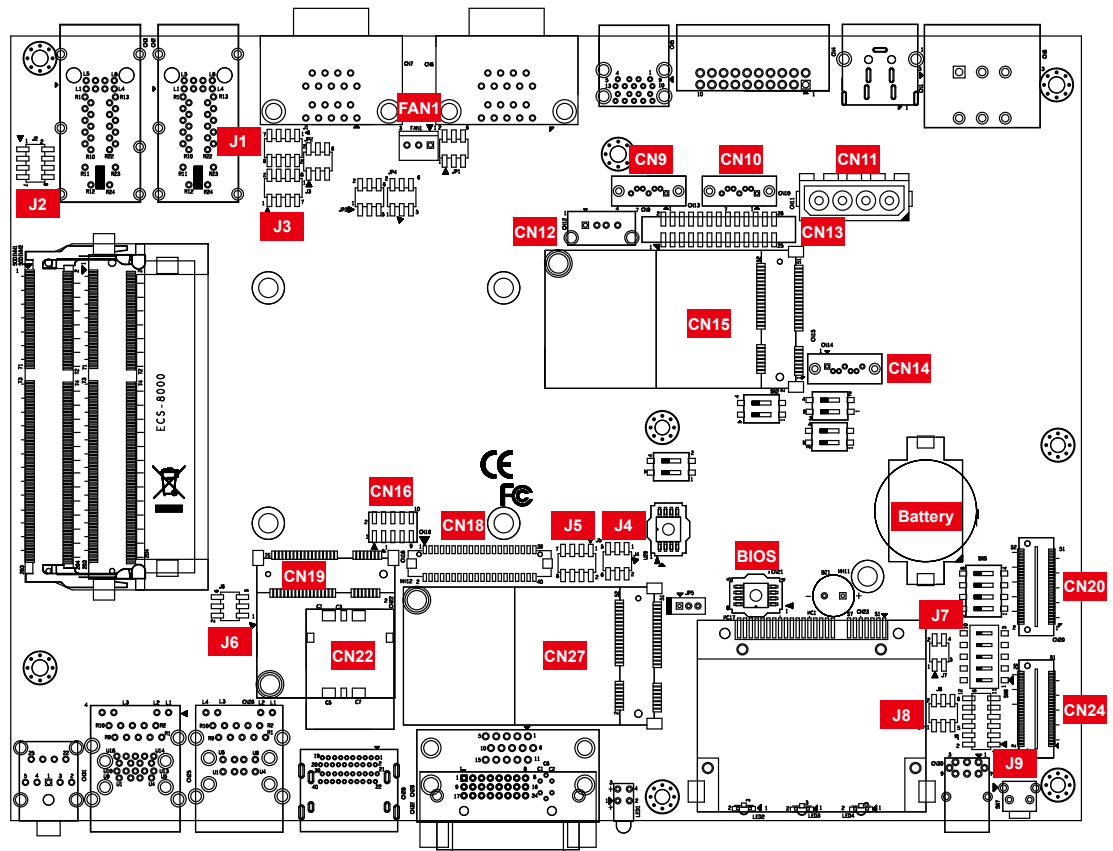

### 2.4.2 Bottom View of ECS-8000 Main Board With Connector Location

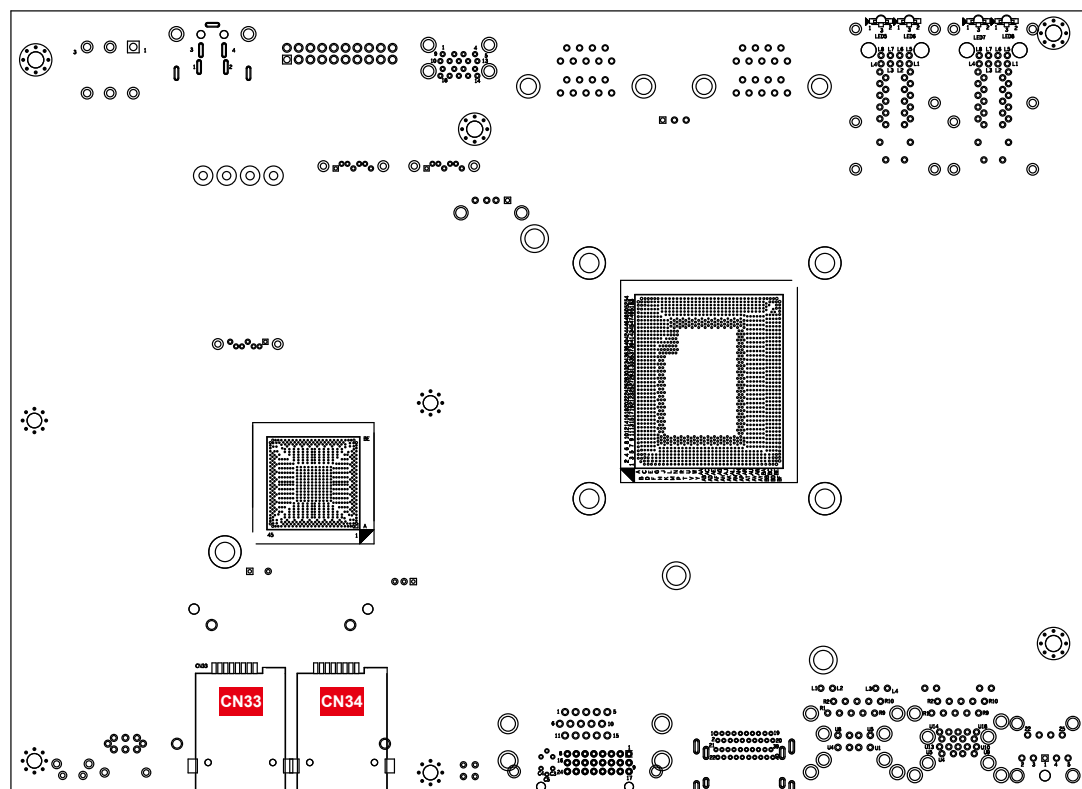

## 2.4.3 J5 Miscellaneous Pin Header

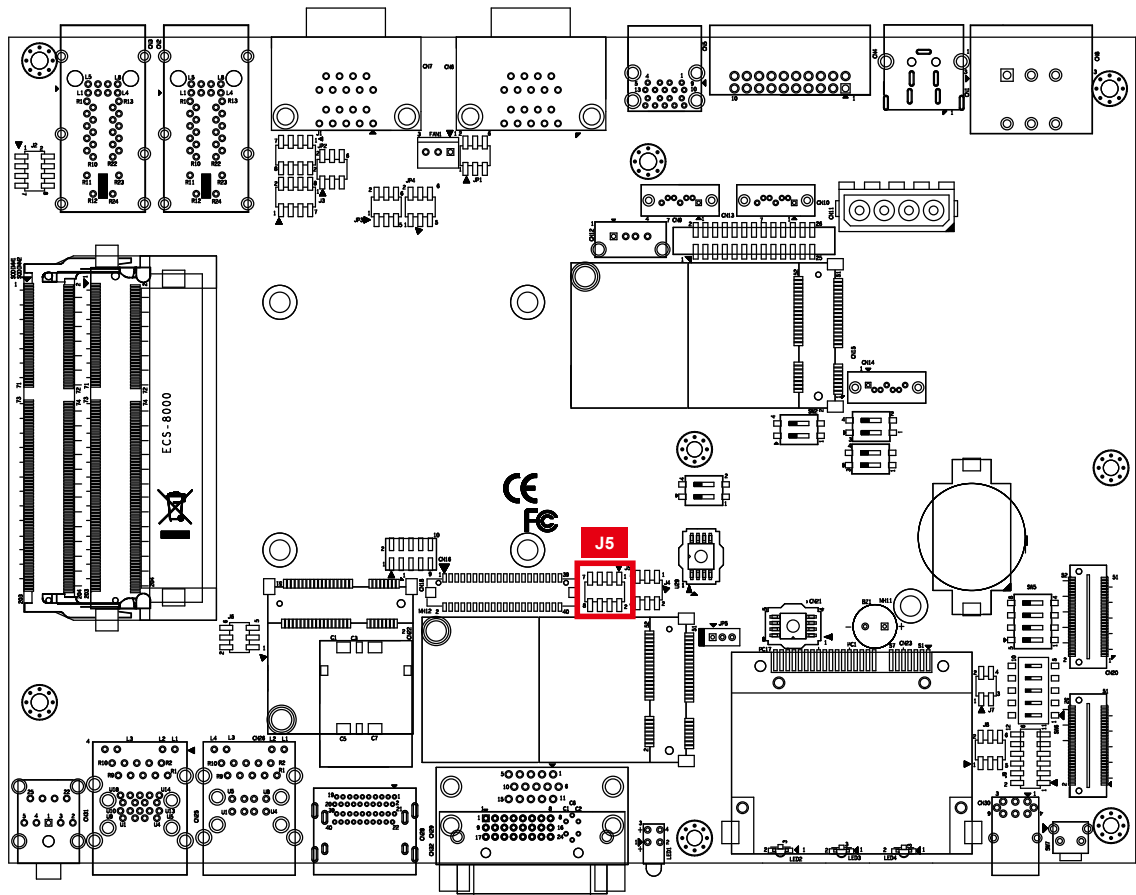

This pin header can be used as a backup for following functions, hard drive LED indicator, reset button, power LED indicator, and power-on/ off button, which already can be accessed by front panel and top panel. The pinouts of Miscellaneous port are listed in following table:

Group	Pin No.	Description
HDD LED	1	HDD_LED_P
	3	HDD_LED_N
RESET BUTTON	5	FP_RST_BTN_N
	7	GND
POWER LED	2	PWR_LED_P
	4	PWR_LED_N
POWER BUTTON	6	FP_PWR_BTN_IN
	8	GND

## 2.4.4 CN16, CN18 eDP

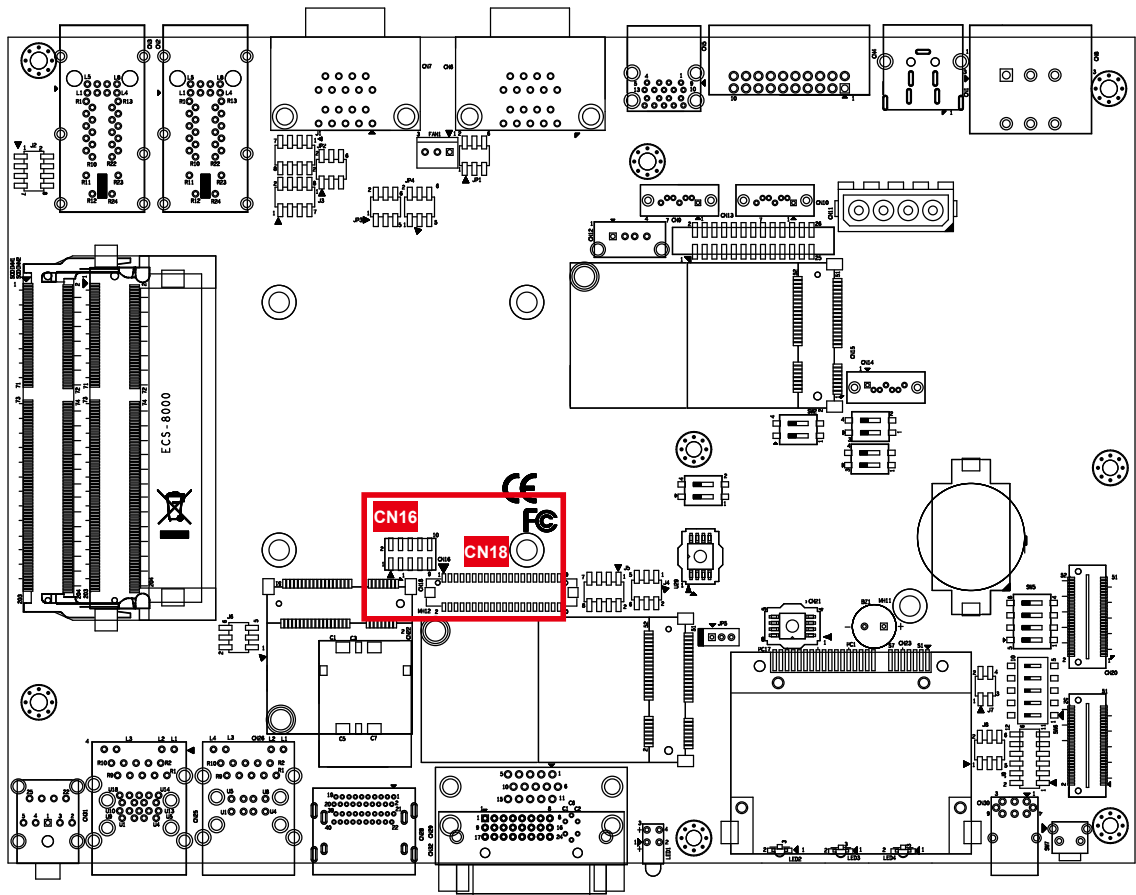

ECS-8000 supports eDP display, up to 4096 x 2304 pixels resolution. The pin assignments of CN18 are listed in the following table:

Pin No.	Definition	Pin No.	Definition
1	GND	11	GND
2	+V3P3S_DP_EMB (+5V / +3.3V)	12	VSS_EDP_AMOLED
3	GND	13	N.C.
4	+V3P3S_DP_EMB (+5V / +3.3V)	14	VSS_EDP_AMOLED
5	GND	15	N.C.
6	+V3P3S_DP_EMB (+5V / +3.3V)	16	+VCC_EDP_BKLT (+12V)
7	GND	17	GND
8	+V3P3S_DP_EMB (+5V / +3.3V)	18	+VCC_EDP_BKLT (+12V)
9	EDP_HPDP	19	N.C.
10	+V3P3S_DP_EMB (+5V / +3.3V)	20	GND

Pin No.	Definition	Pin No.	Definition
21	N.C.	31	EDP_TXN0
22	+V5S_LVDS_BKLT (+5V)	32	+3.3V
23	GND	33	EDP_TXP0
24	N.C.	34	GND
25	EDP_TXN1	35	GND
26	L_BRIGHTNESS	36	N.C.
27	EDP_TXP1	37	EDP_AUXP
28	L_BKLT_EN	38	N.C.
29	GND	39	EDP_AUXN
30	+3.3V	40	N.C.

The LCD inverter is connected to CN16 via a 2x5-pin, 2.0mm pin header providing backlight control. The pin assignments are listed in the following table:

Pin No.	Definition	Pin No.	Definition
1	+5V	6	LVDS_VDD_EN
2	L_BKLT_EN	7	GND
3	N.C.	8	GND
4	L_BRIGHTNESS	9	EDP_UTIL_LS
5	N.C.	10	N.C.

## 2.4.5 CN9, CN10 : SATA III Connector

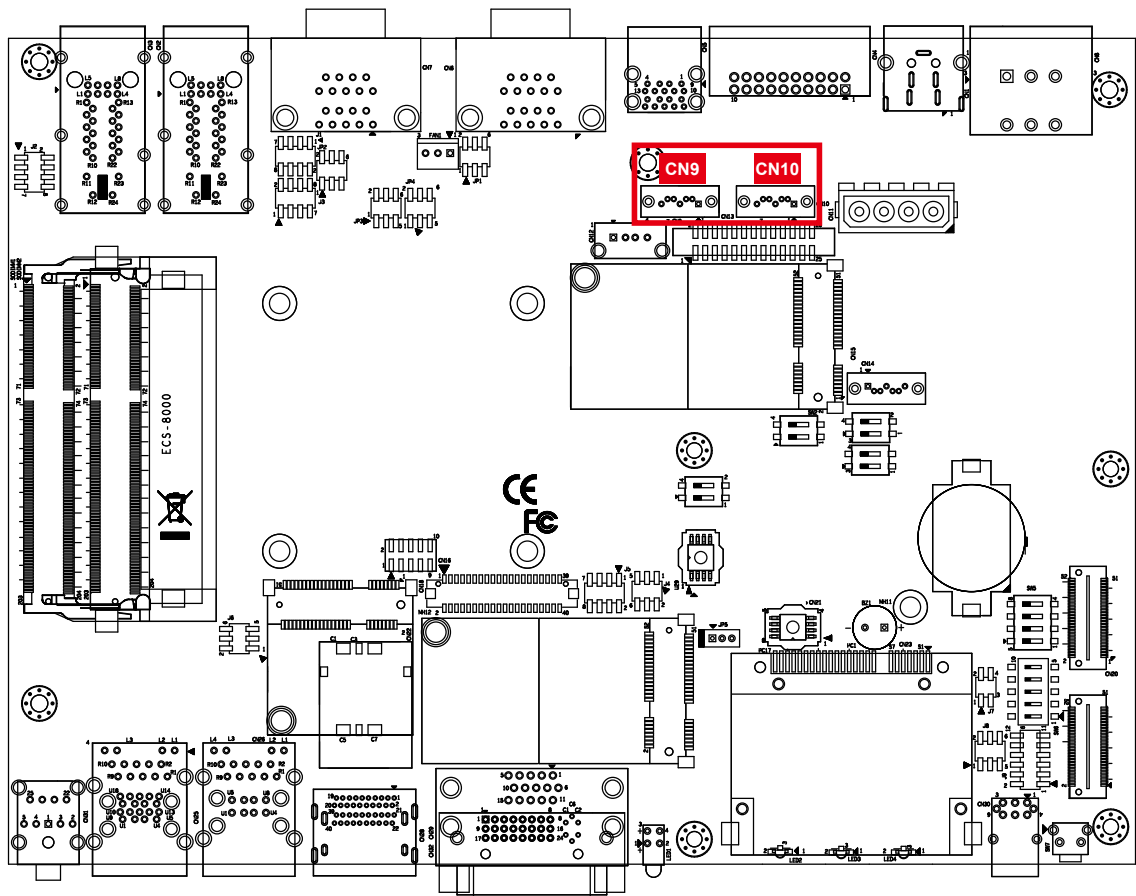

There are 2 onboard high performance Serial ATA III (SATA III) on ECS-8000. It supports higher storage capacity with less cabling effort and smaller required space. The pin assignments of CN9 and CN10 are listed in the following table:

Pin No.	Definition	Pin No.	Definition
1	GND	5	RXN
2	TXP	6	RXP
3	TXN	7	GND
4	GND		

## 2.4.6 CN14 : SATA II Connector

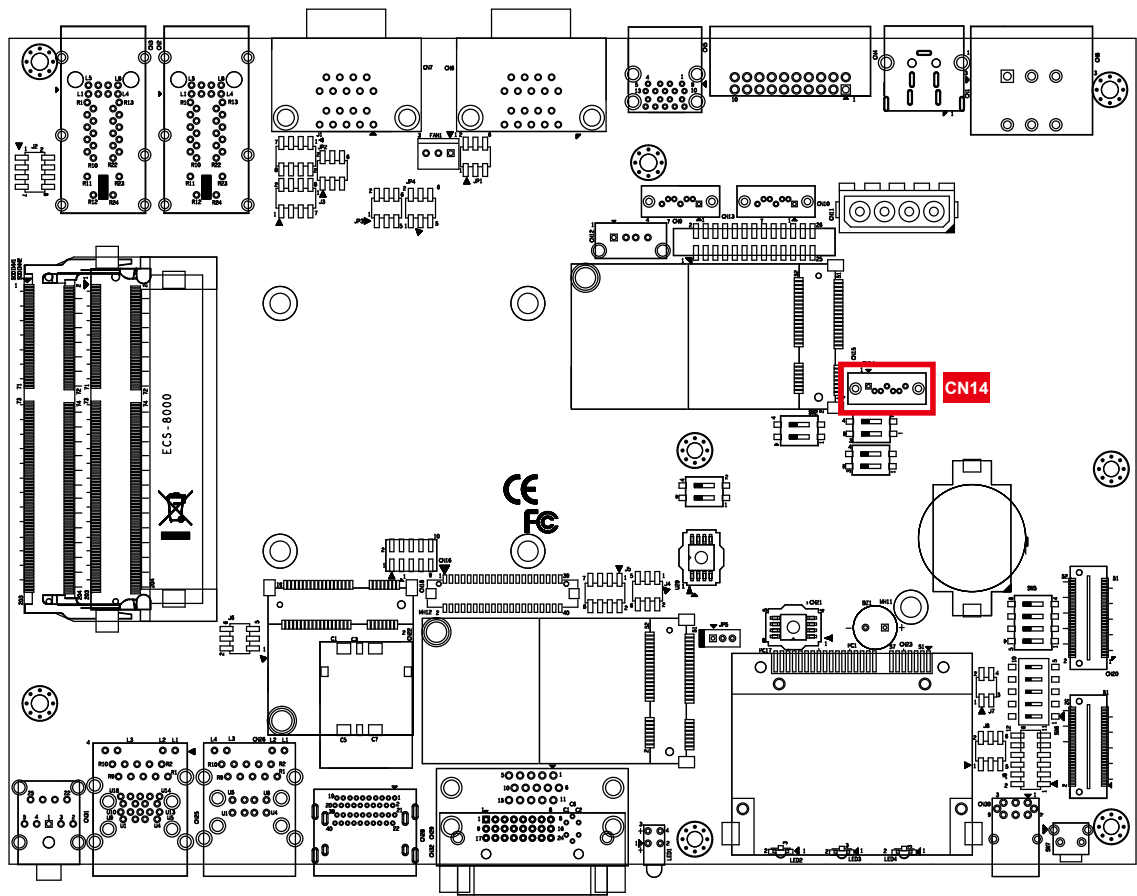

There is a onboard high performance Serial ATA II (SATA II) on ECS-8000. It supports higher storage capacity with less cabling effort and smaller required space. The pin assignments of CN14 are listed in the following table:

Pin No.	Definition	Pin No.	Definition
1	GND	5	RXN
2	TXP	6	RXP
3	TXN	7	GND
4	GND		

## 2.4.7 CN11 : SATA Power Connector

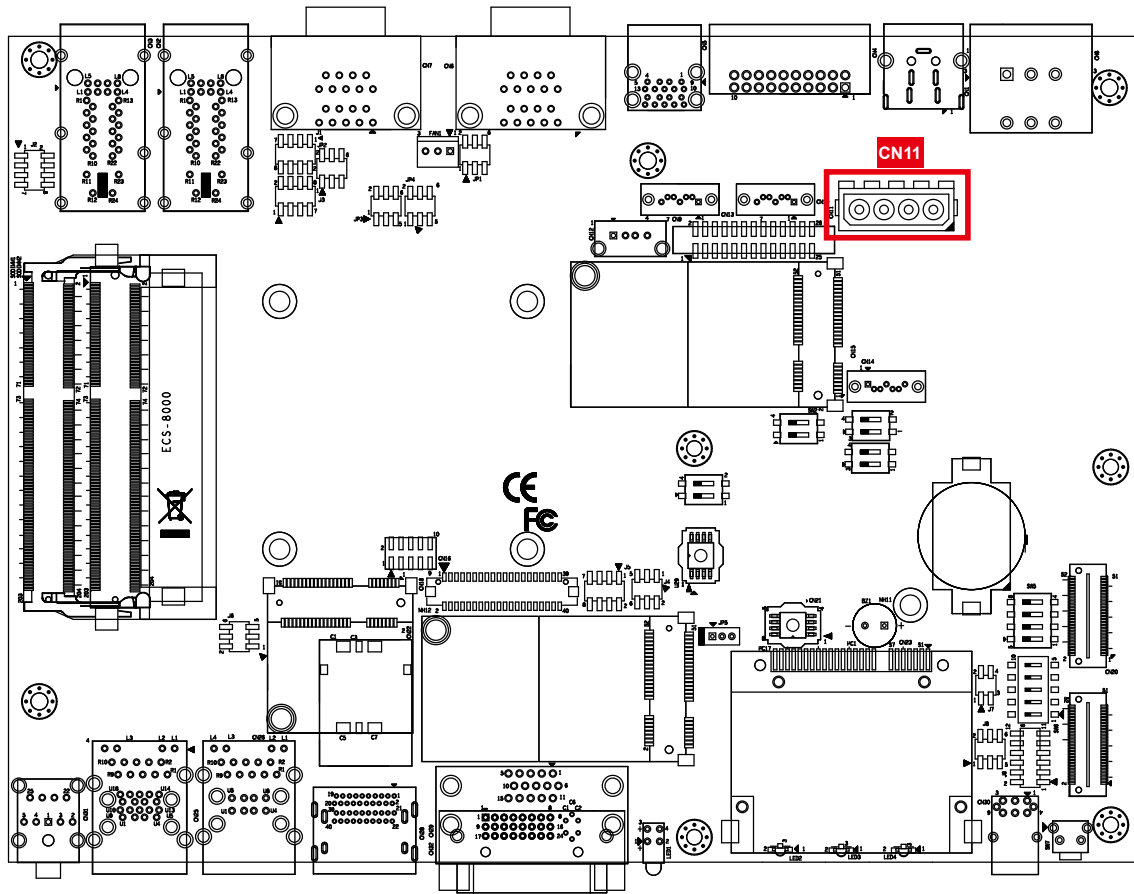

The ECS-8000 also equip with a SATA power connector. It supports 5V (Up to 4A) and 12V (Up to 2A) current to the hard drive or SSD. The pin assignments of CN11 are listed in the following table:

Connector	Pin No.	Description	Pin No.	Description
CN11	1	+12V	3	GND
	2	GND	4	+5V



## 2.4.8 CN12 : Internal USB

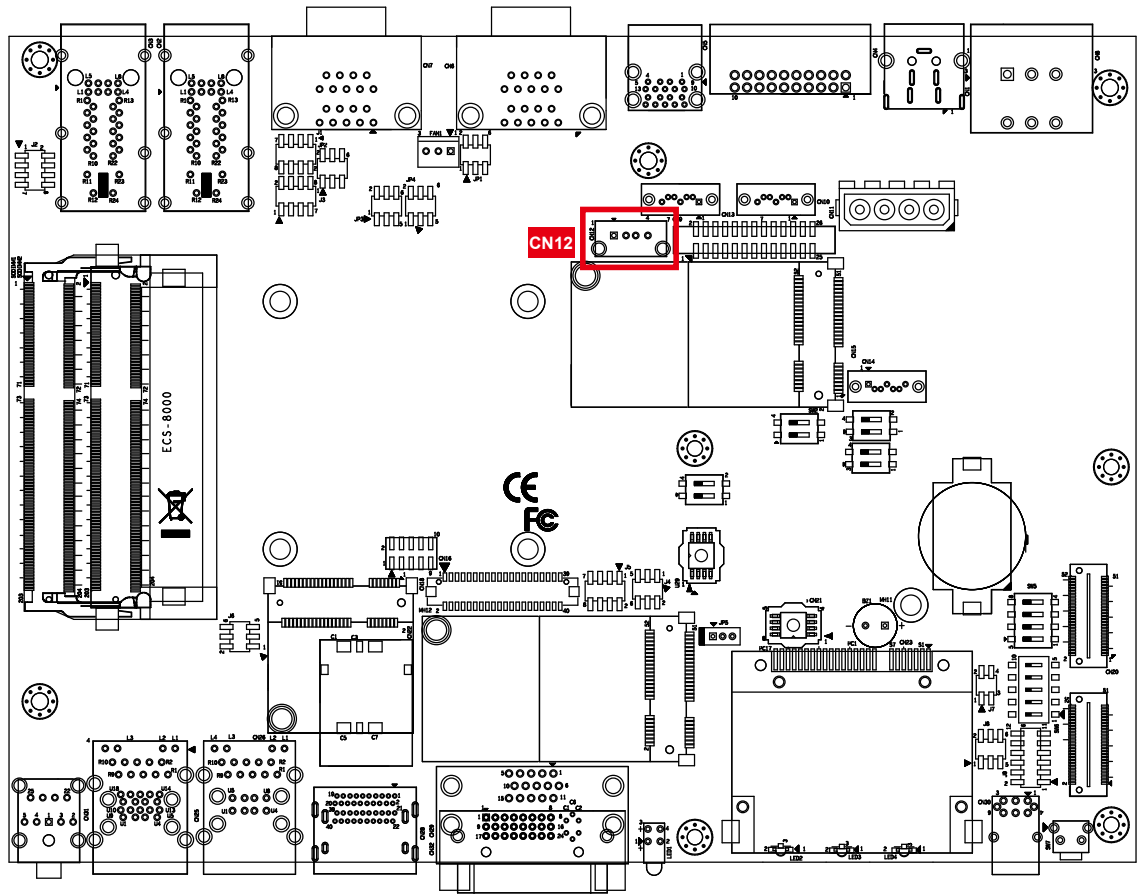

The ECS-8000 main board provide one expansion USB port using plug-and-play for Dongle Key or LCD touch Panel. The USB interface supports 480 Mbps transfer rate which comply with high speed USB specification Rev. 2.0.

The USB interface is accessed through one standard USB 2.0 connector. This USB 2.0 does not support wake up function.

The pin assignments of CN12 are listed in the following table:

Connector	Pin No.	Description	Pin No.	Description
CN12	1	USB_VCC	3	USBD+
	2	USBD-	4	GND

## 2.4.9 CN27, CN15 : Mini PCIe, mSATA

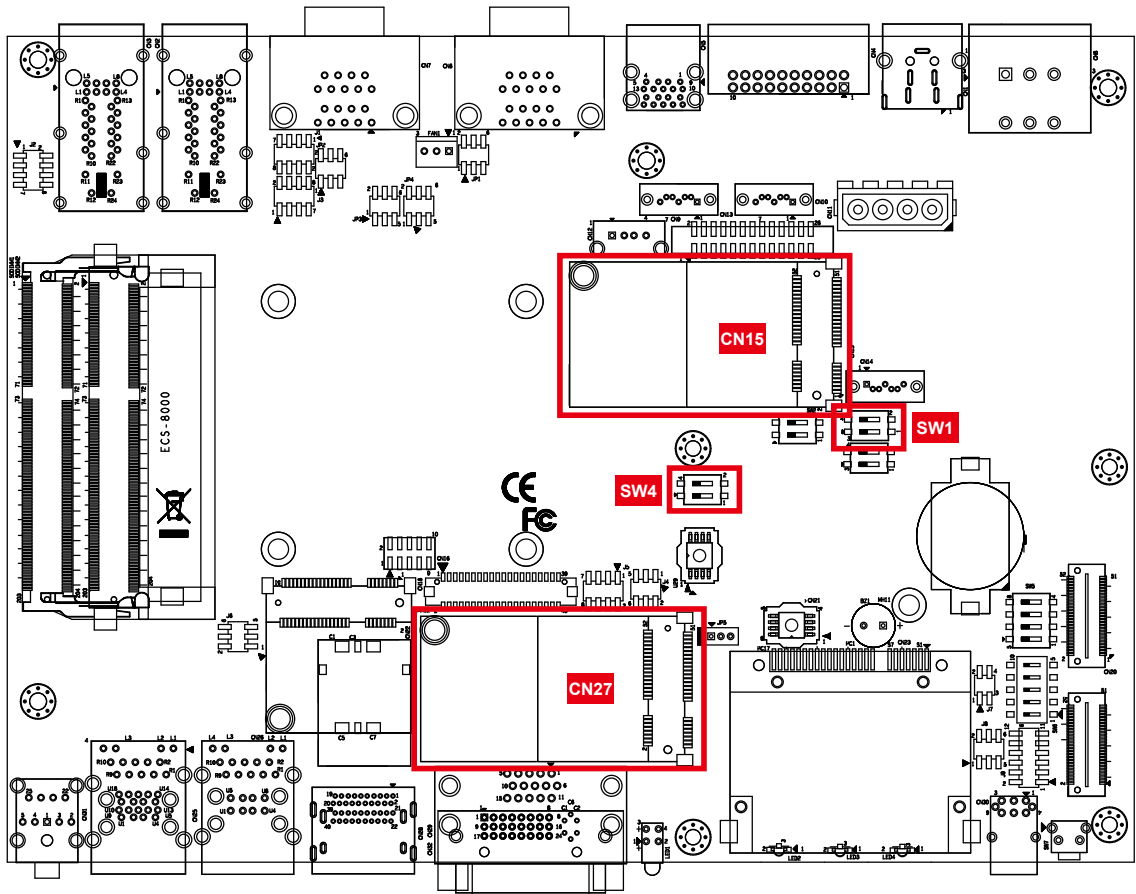

Both mSATA and Mini PCIe share the same form factor and similar electrical pinout assignments on their connectors. There was no clear mechanism to distinguish if a mSATA drive or a Mini PCIe device is plugged into the socket until recently that SATA I/O issued an ECN change (ECN #045) to redefine pin-43 on mSATA connector as “no connect” instead of “return current path” (or GND). When an mSATA drive is inserted, its pin-43 is “no connect”, and the respective pin on the socket is being pulled-up to logic 1. When a Mini PCIe device is inserted, its pin-43 forces the respective pin on the socket to ground, or logic 0. SW4, SW1 Pin-43 are designed for switching mSATA drive and Mini PCIe device.

Mini PCIe	DIP Switch SW 4-1	DIP Switch SW 4-2	Interface
CN27	ON	OFF	*Auto Detection
	OFF	ON	Mini PCI-E (Forced)
	OFF	OFF	mSATA (Forced)

Mini PCIe	DIP Switch SW 1-1	DIP Switch SW 1-2	Interface
CN15	ON	OFF	*Auto Detection
	OFF	ON	Mini PCI-E (Forced)
	OFF	OFF	mSATA (Forced)

The pin assignments of CN27, CN15 are listed in the following table:

Pin No.	Signal Name	Pin No.	Signal Name
51	Reserved	52	+3.3Vaux
49	Reserved	50	GND
47	Reserved	48	+1.5V
45	Reserved	46	Reserved
43	Status	44	Reserved
41	+3.3Vaux	42	Reserved
39	+3.3Vaux	40	GND
37	GND	38	USB_D+
35	GND	36	USB_D-
33	PETp0	34	GND
31	PETn0	32	SMB_DATA
29	GND	30	SMB_CLK
27	GND	28	+1.5V
25	PERp0	26	GND
23	PERn0	24	+3.3Vaux
21	GND	22	PERST#
19	Reserved	20	reserved
17	Reserved	18	GND
Mechanical Key			
15	GND	16	UIM_VPP
13	REFCLK+	14	UIM_RESET
11	REFCLK-	12	UIM_CLK
9	GND	10	UIM_DATA
7	CLKREQ#	8	UIM_PWR
5	Reserved	6	1.5V
3	Reserved	4	GND
1	WAKE#	2	3.3Vaux

## 2.4.10 CN19 : Mini PCIe

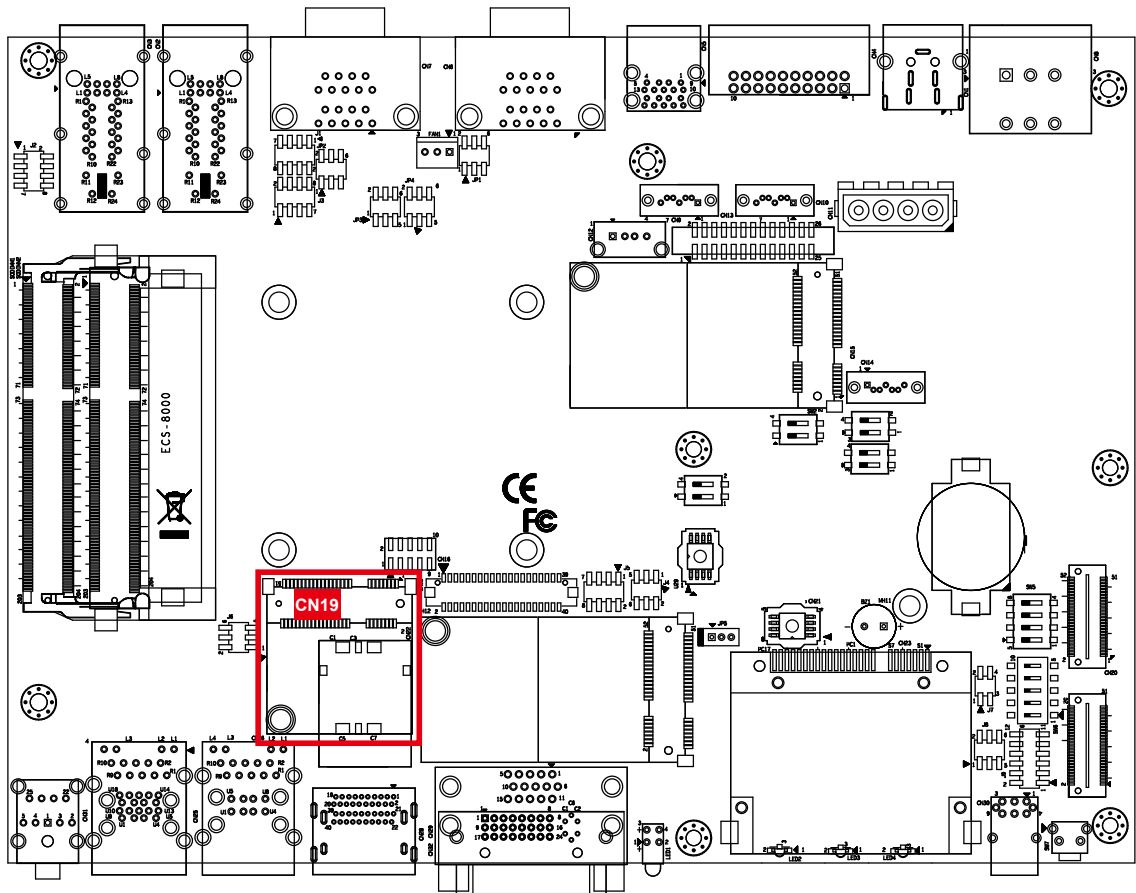

The pin assignments of CN19 are listed in the following table:

Pin No.	Signal Name	Pin No.	Signal Name
51	Reserved	52	+3.3Vaux
49	Reserved	50	GND
47	Reserved	48	+1.5V
45	Reserved	46	Reserved
43	GND	44	Reserved
41	+3.3Vaux	42	Reserved
39	+3.3Vaux	40	GND
37	GND	38	USB_D+
35	GND	36	USB_D-
33	PETp0	34	GND
31	PETn0	32	SMB_DATA
29	GND	30	SMB_CLK
27	GND	28	+1.5V

25	PERp0	26	GND
23	PERn0	24	+3.3Vaux
21	GND	22	PERST#
19	Reserved	20	reserved
17	Reserved	18	GND
Mechanical Key			
15	GND	16	UIM_VPP
13	REFCLK+	14	UIM_RESET
11	REFCLK-	12	UIM_CLK
9	GND	10	UIM_DATA
7	CLKREQ#	8	UIM_PWR
5	Reserved	6	1.5V
3	Reserved	4	GND
1	WAKE#	2	3.3Vaux

## 2.4.10 Battery

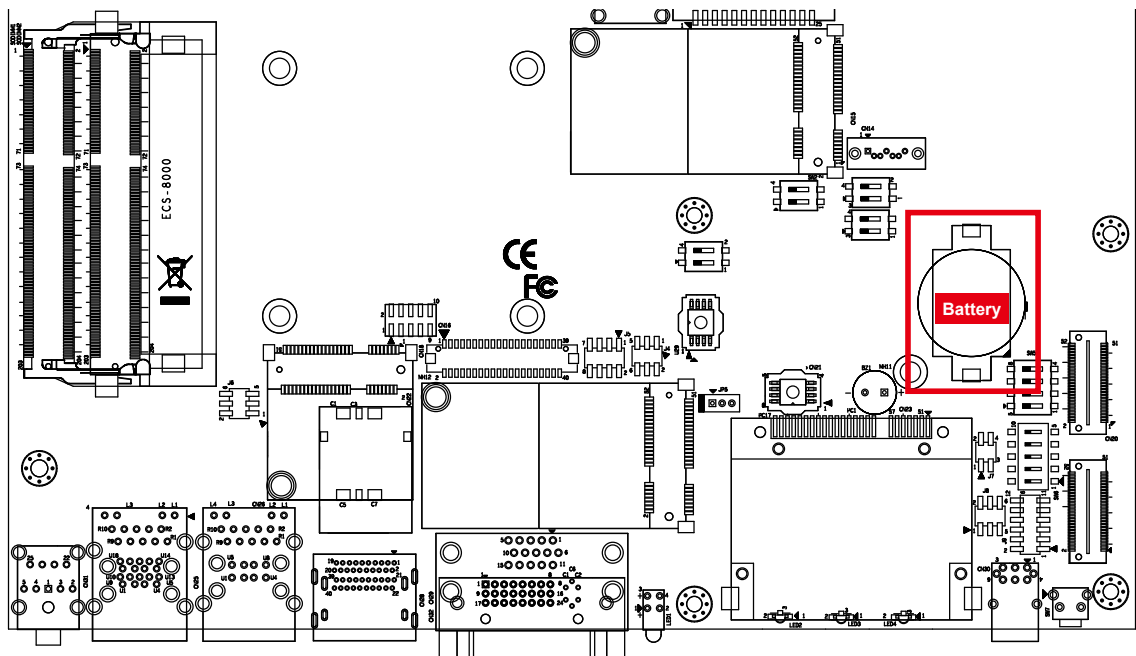

The ECS-8000's real-time clock is powered by a lithium battery. It is Equipped with Panasonic BR2032 190mAh lithium battery. It is recommended that you not replace the lithium battery on your own. If the battery needs to be changed, please contact the Vecow RMA service team.

## 2.4.12 J6 : LAN2 I210 SDP

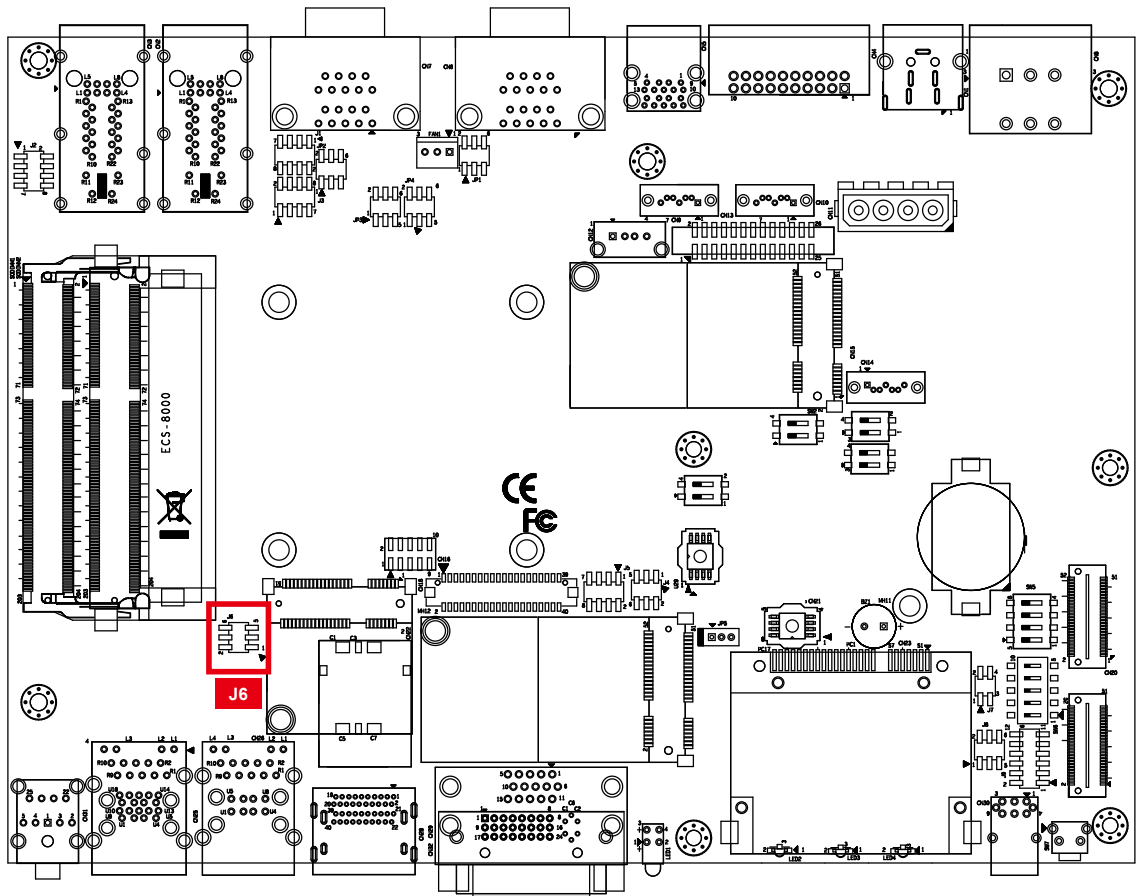

The pin assignments of J6 are listed in the following table:

Pin No.	Function	Pin No.	Function
1	LAN2_SDP0	4	LAN2_SDP3
2	LAN2_SDP1	5	GND
3	LAN2_SDP2	6	GND

## 2.4.13 CN13 : GPIO

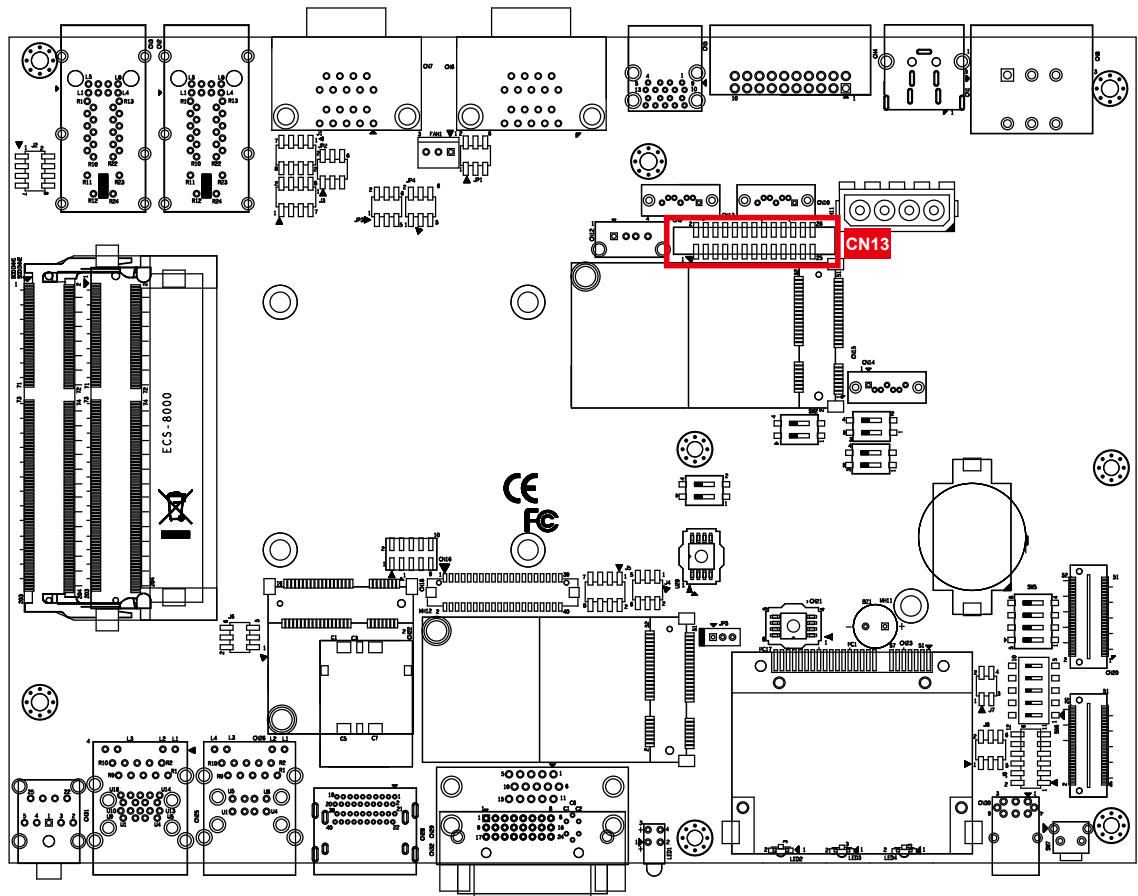

The ECS-8000 offers 16 programmable I/O within TTL 5V (1mA max. /pin) tolerance. If the GPIO is logic high, it indicates that the mapping SIO GPIO pin is logic high level. If the GPIO is logic low, it indicates that the mapping SIO GPIO pin is logic low level.

Pin No.	Function	Pin No.	Function
1	GND	14	GND
2	SIO_GP11	15	SIO_GP37
3	SIO_GP12	16	SIO_GP50
4	SIO_GP15	17	SIO_GP51
5	SIO_GP16	18	SIO_GP52
6	GND	19	GND
7	SIO_GP32	20	SIO_GP56
8	SIO_GP33	21	SIO_GP57
9	SIO_GP35	22	SIO_GP64
10	SIO_GP36	23	SIO_GP65

11	GND	24	GND
12	SMB_DATA	25	+5V
13	SMB_CLK	26	+5V

### 2.4.14 FAN 1

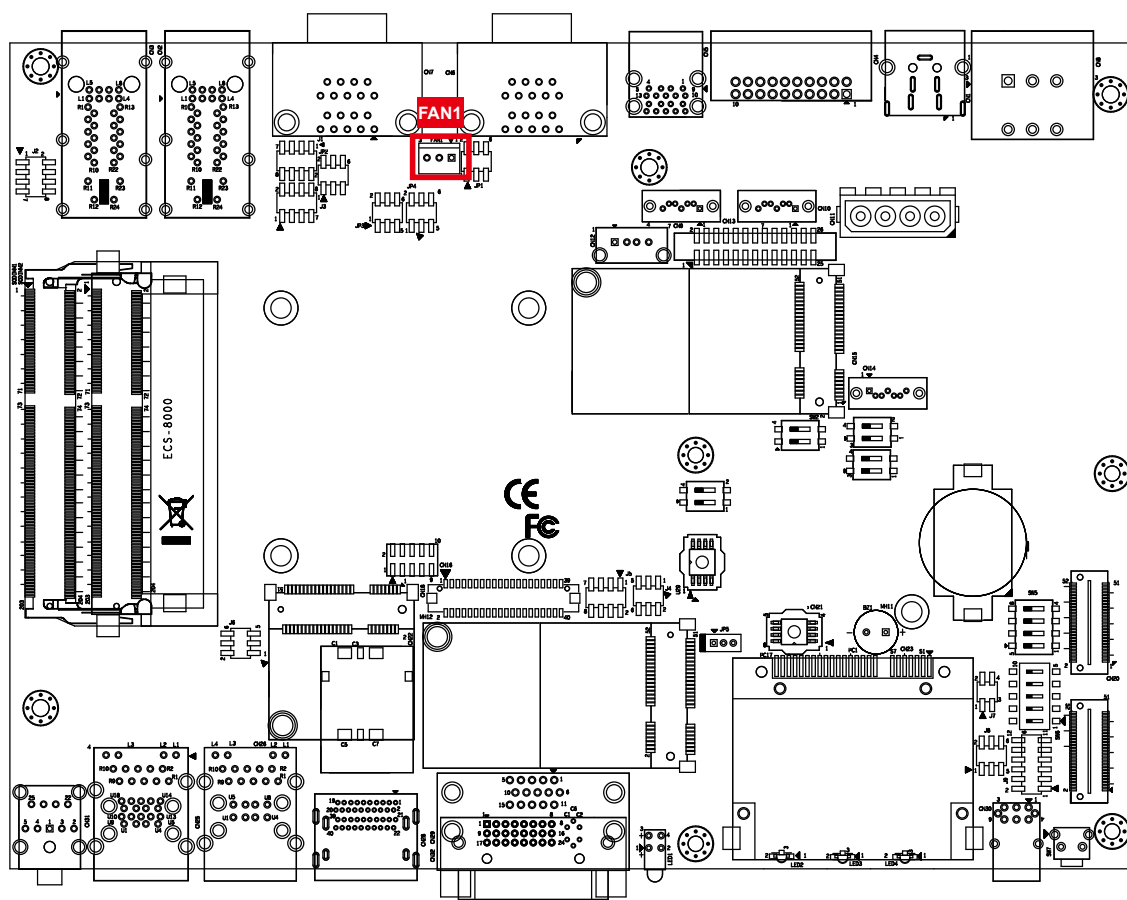

Fan power connector supports for additional thermal requirements. The pin assignments of FAN 1 are listed in the following table:

Pin No.	Function	Pin No.	Function
1	GND	3	Fan speed sensor
2	+12V (1.5A max)		



## 2.4.15 J4:SGPIO

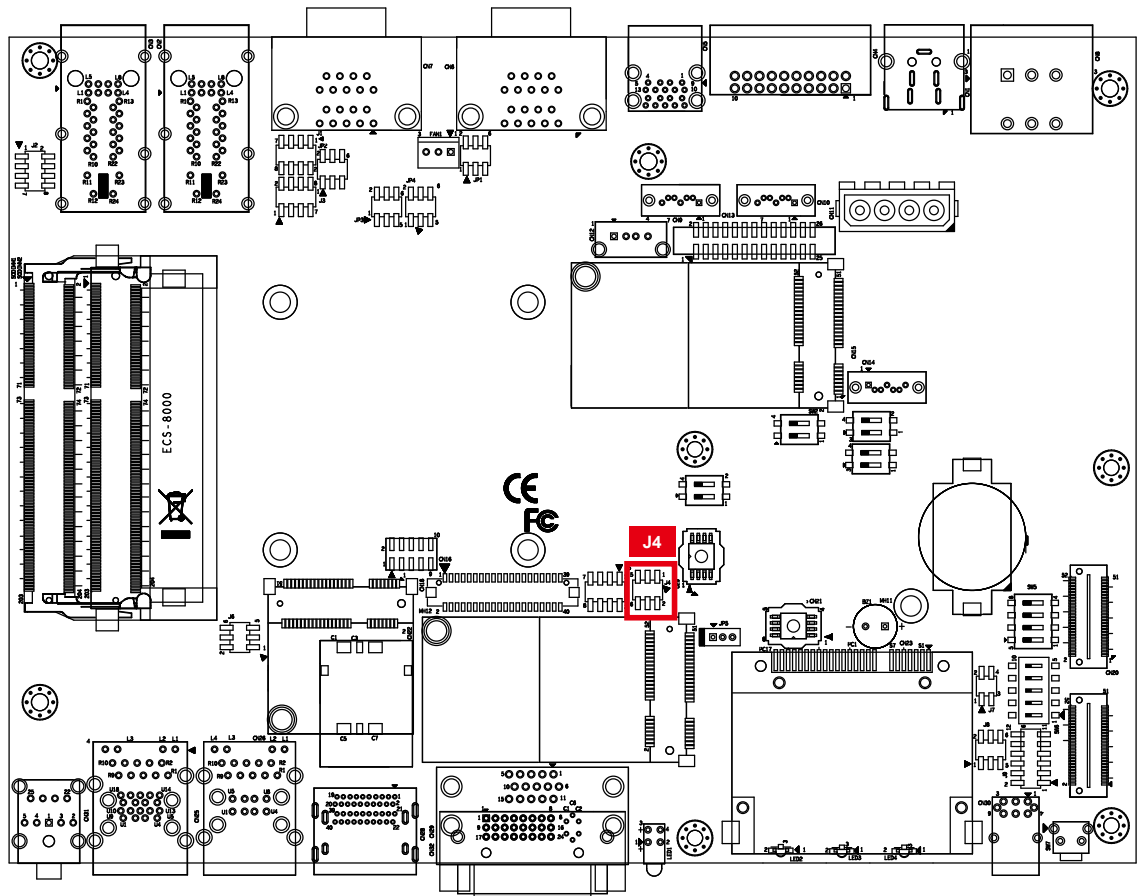

The pin assignments of J4 are listed in the following table:

Pin No.	Function	Pin No.	Function
1	SCLOCK	4	GND
2	SDATA_OUT0	5	SDATA_OUT1
3	SLOAD	6	GND

## 2.4.16 J7 : MCU Spy-bi wire Interface For download FW

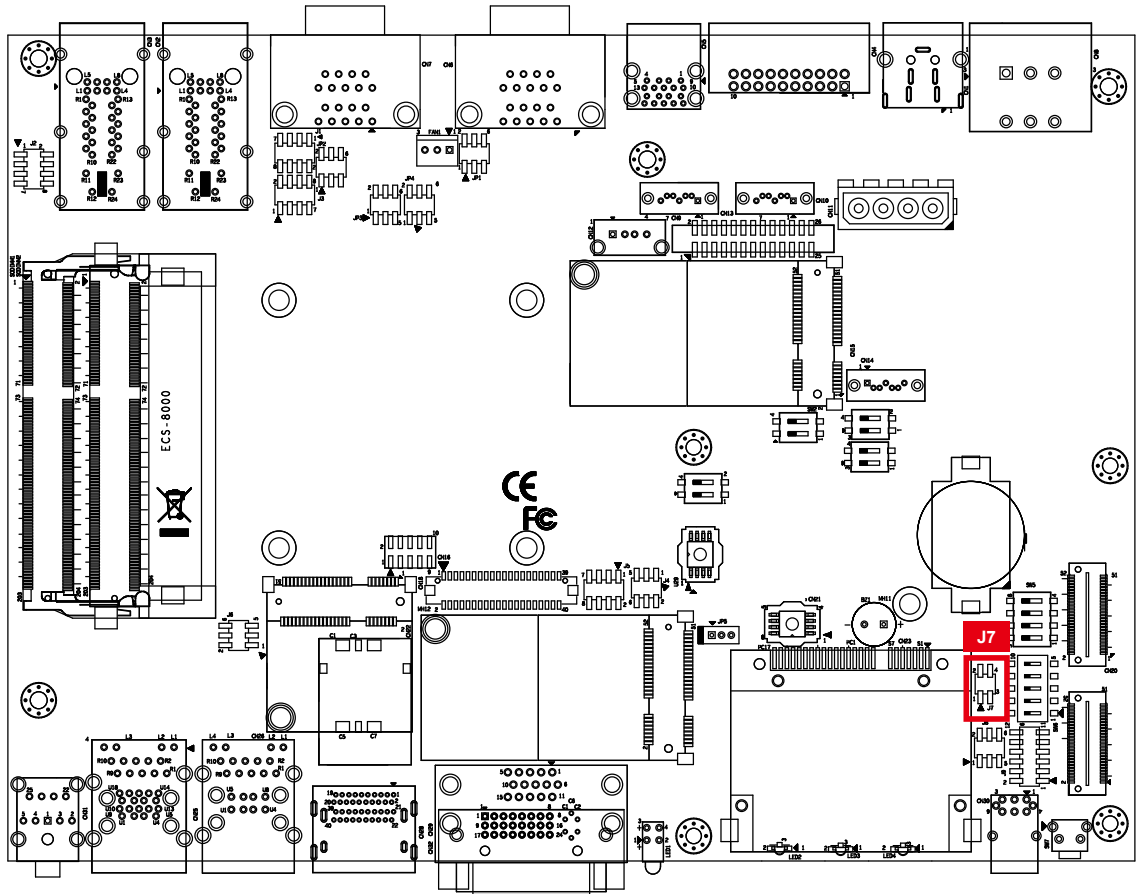

The pin assignments of J7 are listed in the following table:

Pin No.	Function	Pin No.	Function
1	GND	4	3.3V_MCU
2	MCU_RST#	5	MCU_PRG

## 2.4.17 CN20, CN24 SUMMIT

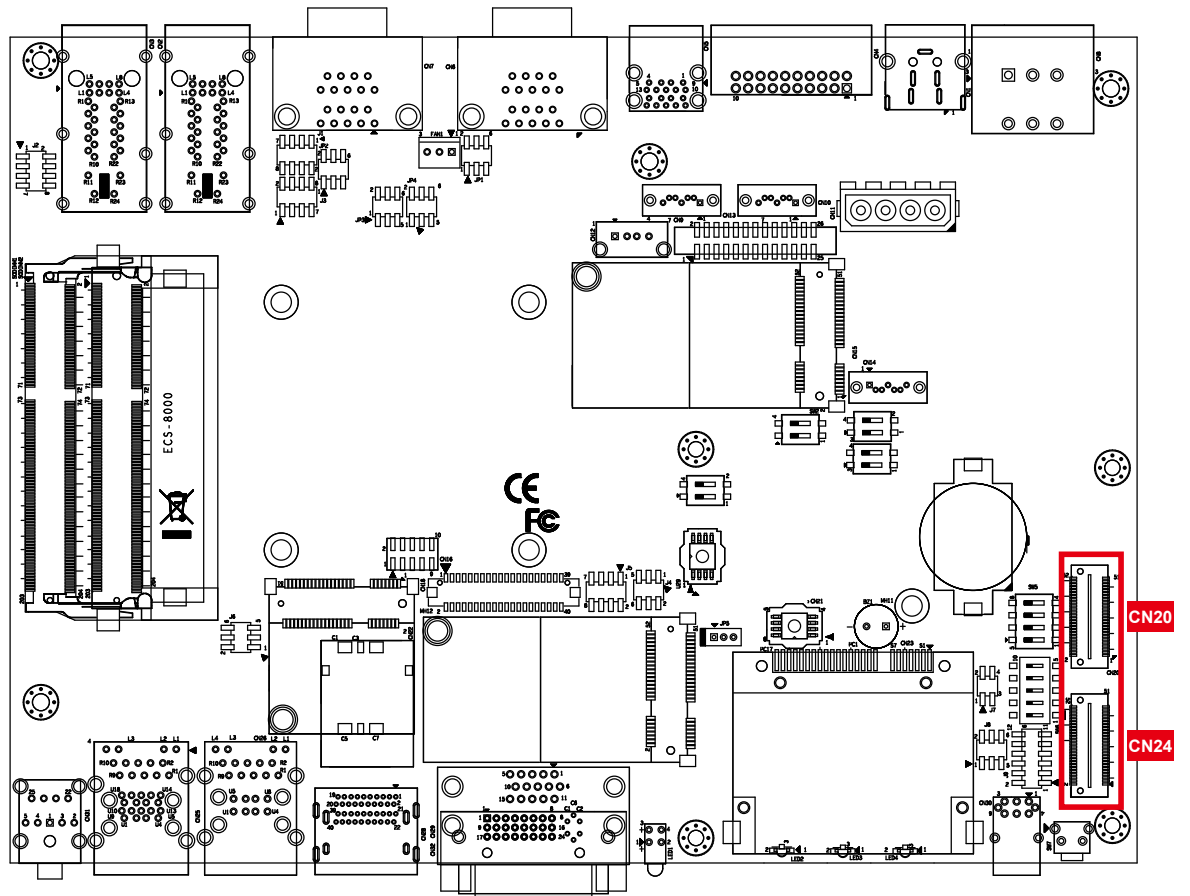

## CN24 Pin out

Pin No.	function	Pin No.	function
1	+5V_AUX	2	+12V
3	+3.3V	4	SMB_DATA
5	+3.3V	6	XMB_CLK
7	Reserved	8	Reserved
9	Reserved	10	SPI_MISO
11	USB_OC#	12	SPI_MOSI
13	Reserved	14	SPI_CLK
15	+5V	16	SPI_CS10
17	USB_3+	18	SPI_CS1#
19	USB_3-	20	Reserved
21	+5V	22	LPC_DRQ1#
23	USB_2+	24	LPC_AD0
25	USB_2-	26	LPC_AD1
27	+5V	28	LPC_AD2
29	USB_1+	30	LPC_AD3
31	USB_1-	32	LPC_FRAME#
33	+5V	34	SERIRQ#
35	USB_0+	36	Reserved
37	USB_0-	38	CLK_33MHz
39	GND	40	GND
41	A_PET_P0	42	A_PER_P0
43	A_PET_N0	44	A_PER_N0
45	GND	46	APRSNT#/A_PE_CLKREQ#
47	PERST#	48	A_CLKP
49	WAKE#	50	A_CLKN
51	+5V	52	GND

## CN20 Pin out

Pin No.	function	Pin No.	function
1	GND	2	GND
3	B_PET_P0	4	B_PER_P0
5	B_PET_N0	6	B_PER_N0
7	GND	8	GND
9	C_CLKP	10	B_CLKP
11	C_CLKN	12	B_CLKN
13	CPRSNT#/C_PE_CLKREQ#	14	GND
15	C_PET_P0	16	C_PER_P0
17	C_PET_N0	18	C_PER_N0
19	GND	20	GND
21	C_PET_P1	22	C_PER_P1
23	C_PET_N1	24	C_PER_N1
25	GND	26	GND
27	C_PET_P2	28	C_PER_P2
29	C_PET_N2	30	C_PER_N2
31	GND	32	GND
33	C_PET_P3	34	C_PER_P3
35	C_PET_N3	36	C_PER_N3
37	GND	38	GND
39	PERST#	40	WAKE#
41	Reserved	42	Reserved
43	+5V	44	Reserved
45	+5V	46	+3.3V
47	+5V	48	+3.3V
49	+5V	50	+3.3V
51	+5V	52	+5V_AUX

## 2.4.18 J1: PoE Power LED Indicator Pin Header

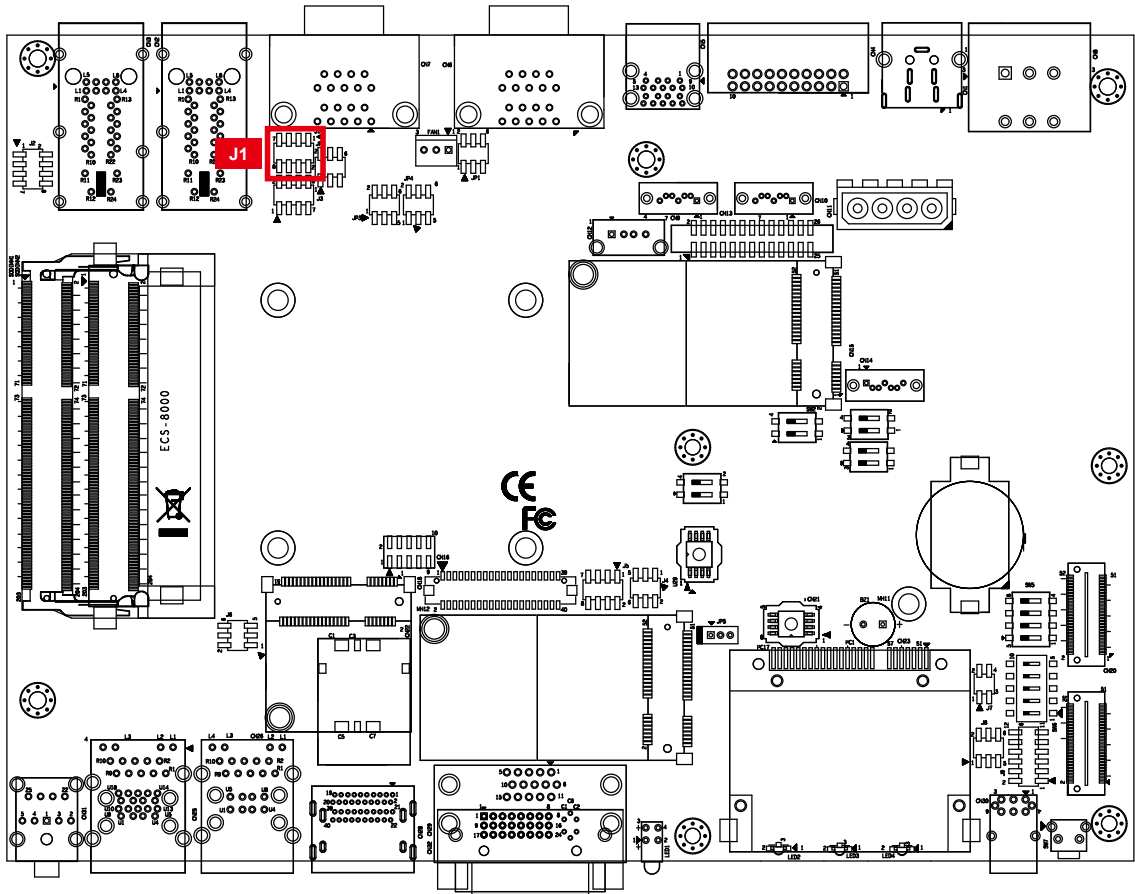

This pin header can be used as a backup for PoE power LED indicator, which already can be accessed by rear panel and bottom panel. The pinouts of LEDs port are listed in following table:

Pin No.	Function	Pin No.	Function
1	POE_LED_LAN6	5	POE_LED_LAN4
2	GND_POE	6	GND_POE
3	POE_LED_LAN5	7	POE_LED_LAN3
4	GND_POE	8	GND_POE

Note: Do not connect GND\_POE to Digital Ground (GND)

## 2.4.19 J2, J3: LAN3~LAN6 GbE LED Pin Header

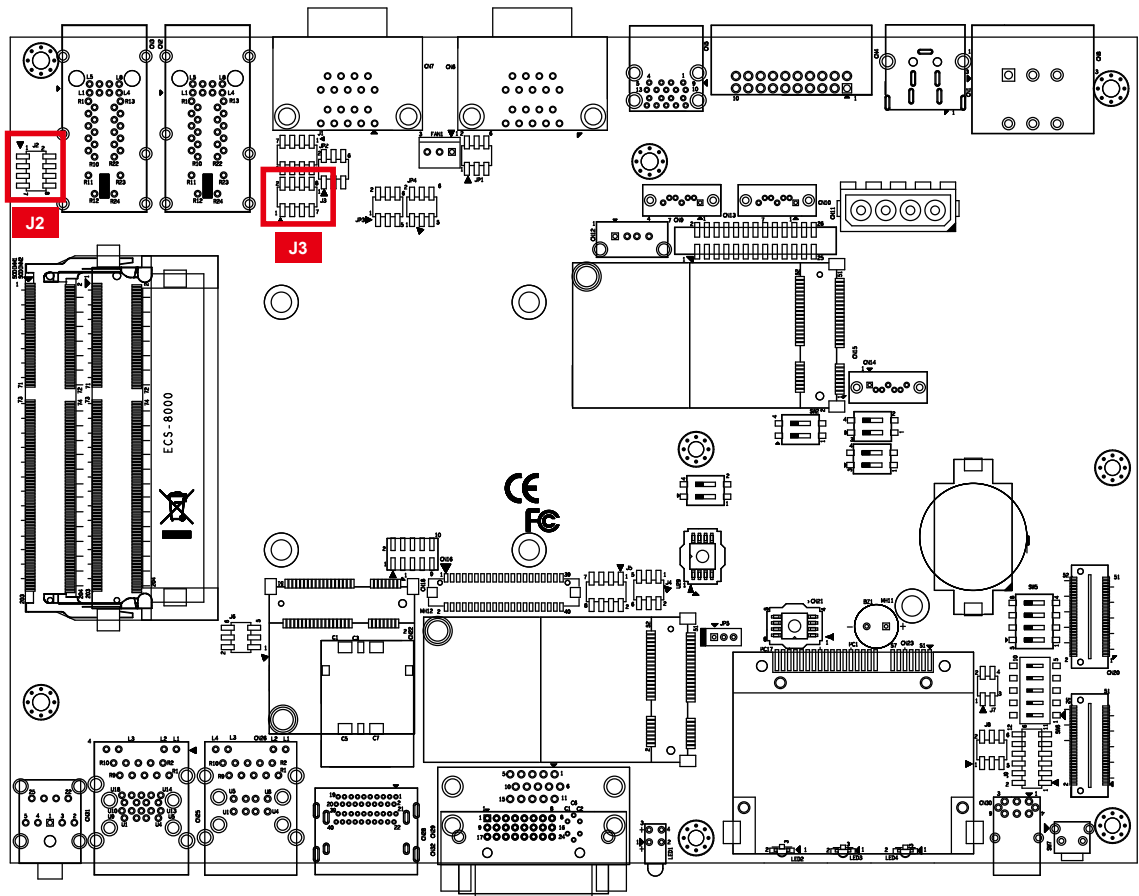

These pin headers can be used as a backup for LAN3~LAN6 GbE LED indicator, which already can be accessed by rear panel. The pinouts of LEDs port are listed in following table:

Connector	Pin No.	Description	Pin No.	Description
J2	1	LAN3_LINK100#	5	LAN3_ACT#
	2	LAN4_LINK100#	6	LAN4_ACT#
	3	LAN3_LINK1000#	7	+V3P3_SB
	4	LAN4_LINK1000#	8	+V3P3_SB

Connector	Pin No.	Description	Pin No.	Description
J3	1	LAN5_LINK100#	5	LAN5_ACT#
	2	LAN6_LINK100#	6	LAN6_ACT#
	3	LAN5_LINK1000#	7	+V3P3_SB
	4	LAN6_LINK1000#	8	+V3P3_SB

## 2.4.20 J9: LPC Port 80 Debug Port

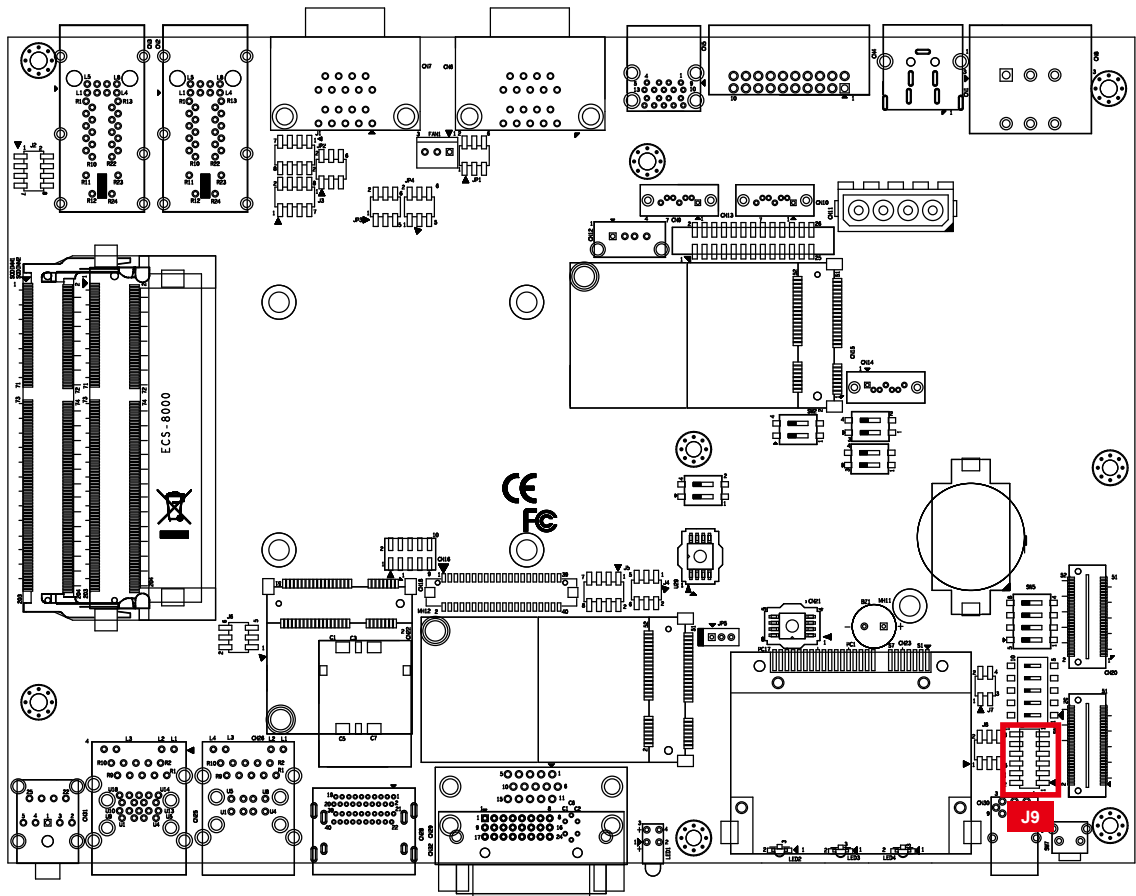

The pin assignments of J9 are listed in the following table:

Pin No.	Function	Pin No.	Function
1	INT_SERIRQ	7	PCH_LFRAME_N
2	+3.3V (0.5A max.)	8	PCH_LPC_LAD0
3	PCH_LPC_LAD3	9	Mechanical Key
4	PLTRST_SIO#	10	GND
5	PCH_LPC_LAD1	11	CLK_PORT80_33M
6	PCH_LPC_LAD2	12	GND



## 2.5 Main Board Jumper Settings

### 2.5.1 Front View of ECS-8000 Main Board with Jumper Location

The figure below is the top view of the ECS-8000 main board which is the main board used in the ECS-8000 Series system. It shows the location of the jumpers.

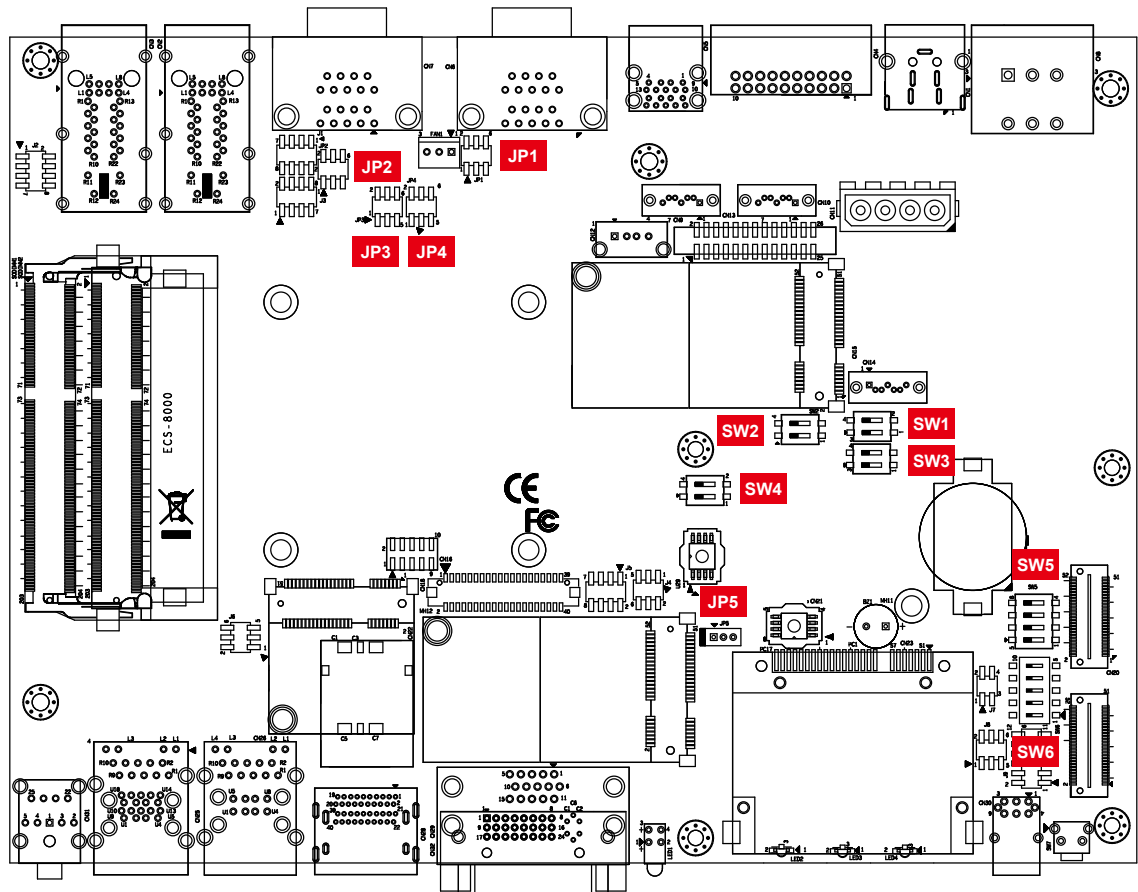

You may configure your card to match the needs of your application by setting jumpers. A jumper is a metal bridge used to close an electric circuit. It consists of two metal pins and a small metal clip (often protected by a plastic cover) that slides over the pins to connect them. To “close” a jumper, you connect the pins with the clip. To “open” a jumper, you remove the clip. Sometimes a jumper will have three pins, labeled 1, 2 and 3. In this case you would connect either pins 1 and 2, or 2 and 3.

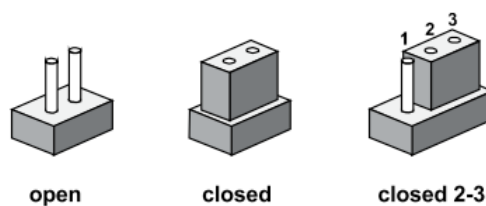

## 2.5.2 JP1, JP2, JP3, JP4: COM Port Pin-9 RI/+5V/+12V Selection

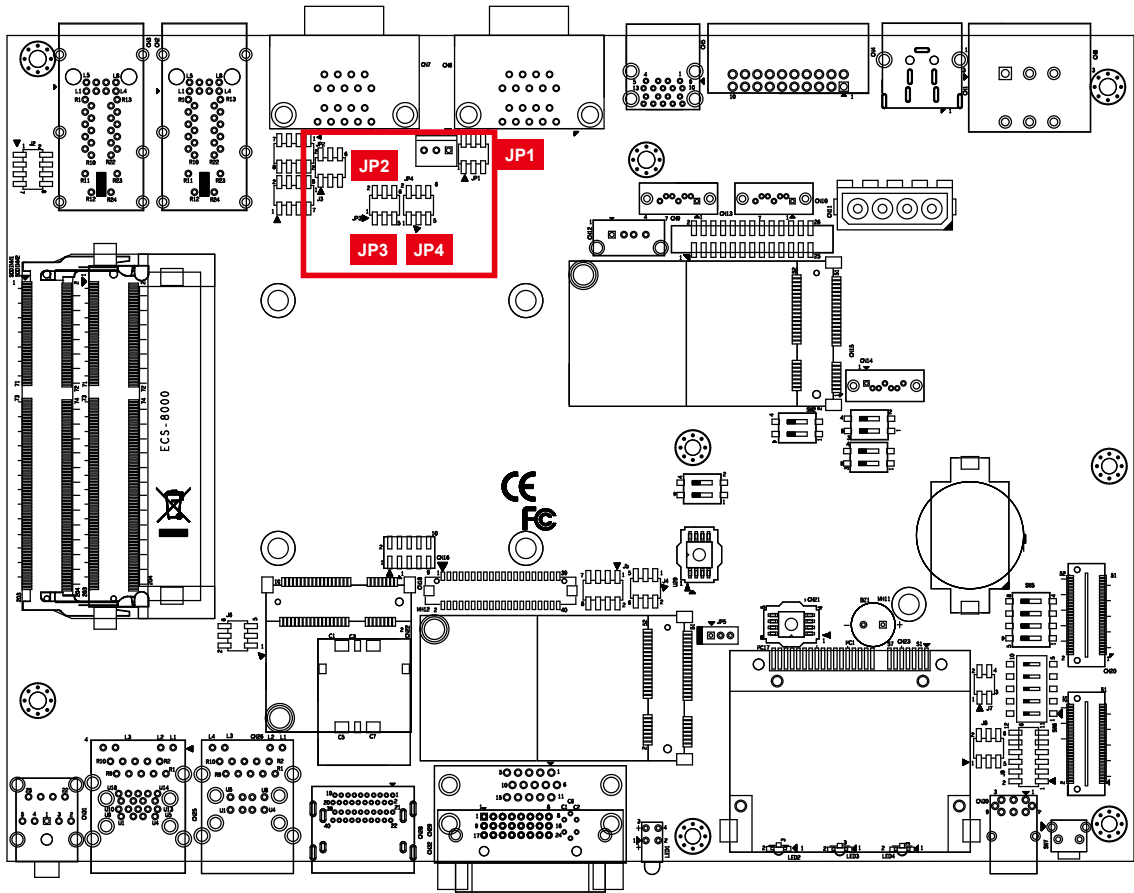

Pin Header	Pin No.	Description
COM1 JP3	1 - 2	+5V (1A max.)
	3 - 4	+12V (0.5A max.)
	5 - 6	*RI

Pin Header	Pin No.	Description
COM2 JP2	1 - 2	+5V (1A max.)
	3 - 4	+12V (0.5A max.)
	5 - 6	*RI

Pin Header	Pin No.	Description
COM3 JP4	1 - 2	+5V (1A max.)
	3 - 4	+12V (0.5A max.)
	5 - 6	*RI

Pin Header	Pin No.	Description
COM4 JP1	1 - 2	+5V (1A max.)
	3 - 4	+12V (0.5A max.)
	5 - 6	*RI

### 2.5.3 JP5 : LVDS Backlight, Power Selection

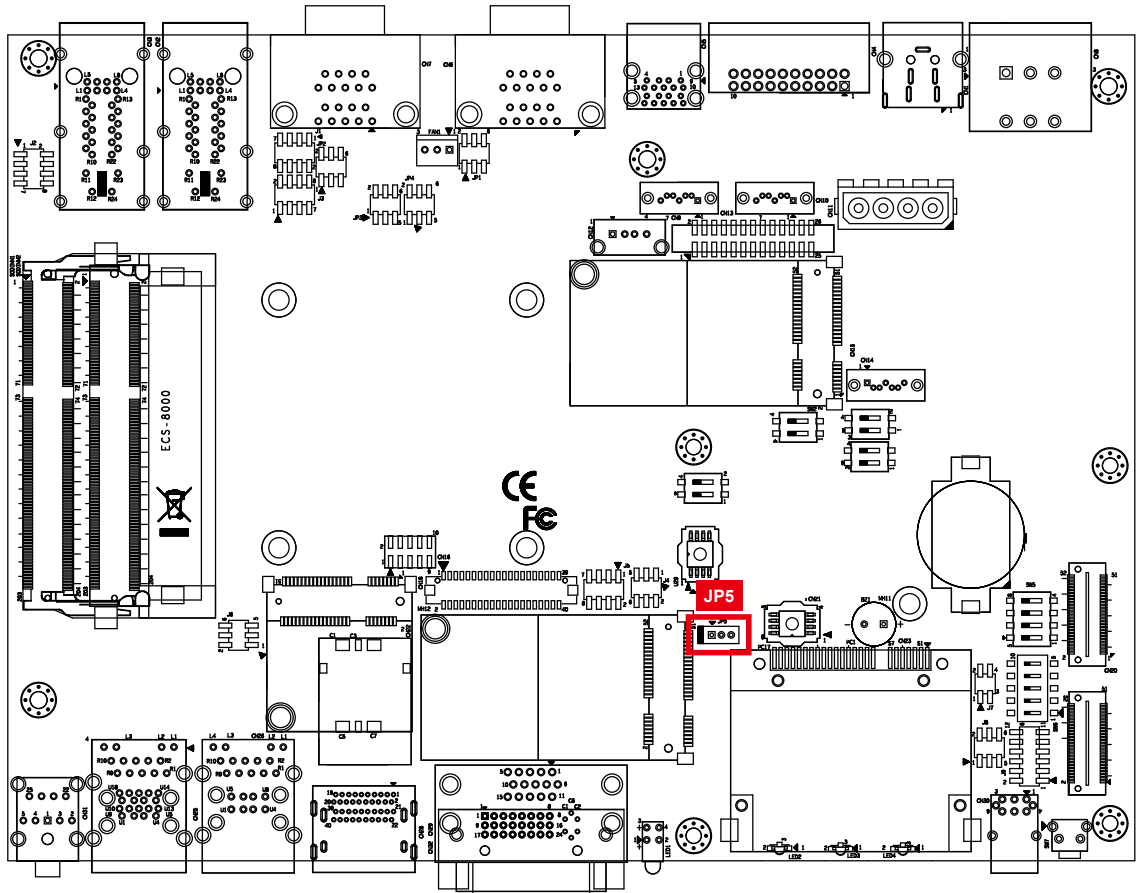

JP5 provides LVDS voltage selection function, closing Pin 1, 2 is for 3.3V LVDS power input; closing Pin 2, 3 is for 5V LVDS power input.

Pin No.	Function	Pin No.	Function
1-2	+3.3V (Default)	2-3	+5V

## 2.5.4 SW6: CMOS / ME / eDP / USB Wake Up

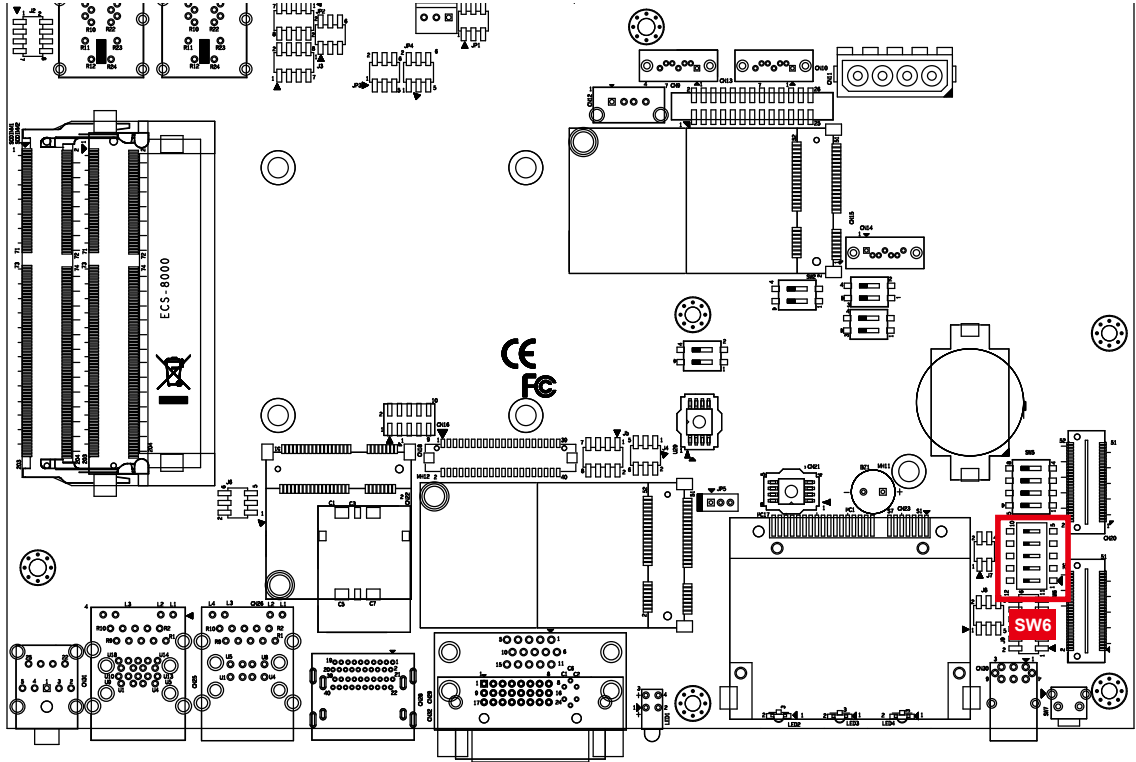

Function	DIP Switch SW 6-1	Description
CMOS Clear Setting	ON	Clear CMOS
	OFF	*Normal

Function	DIP Switch SW 6-2	Description
ME Clear Setting	ON	Clear ME
	OFF	*Normal

Function	DIP Switch SW 6-3	Description
eDP Enable	ON	Enable
	OFF	*Disable

Function	DIP Switch SW 6-4	Description
Front USB3.0 / USB2.0 Wake Up	ON	Disable
	OFF	*Enable

Function	DIP Switch SW 6-5	Description
Rear USB3.0 Wake Up	ON	Disable
	OFF	*Enable

## 2.5.5 SW2, SW3: RS-422/485 Receiver Terminator

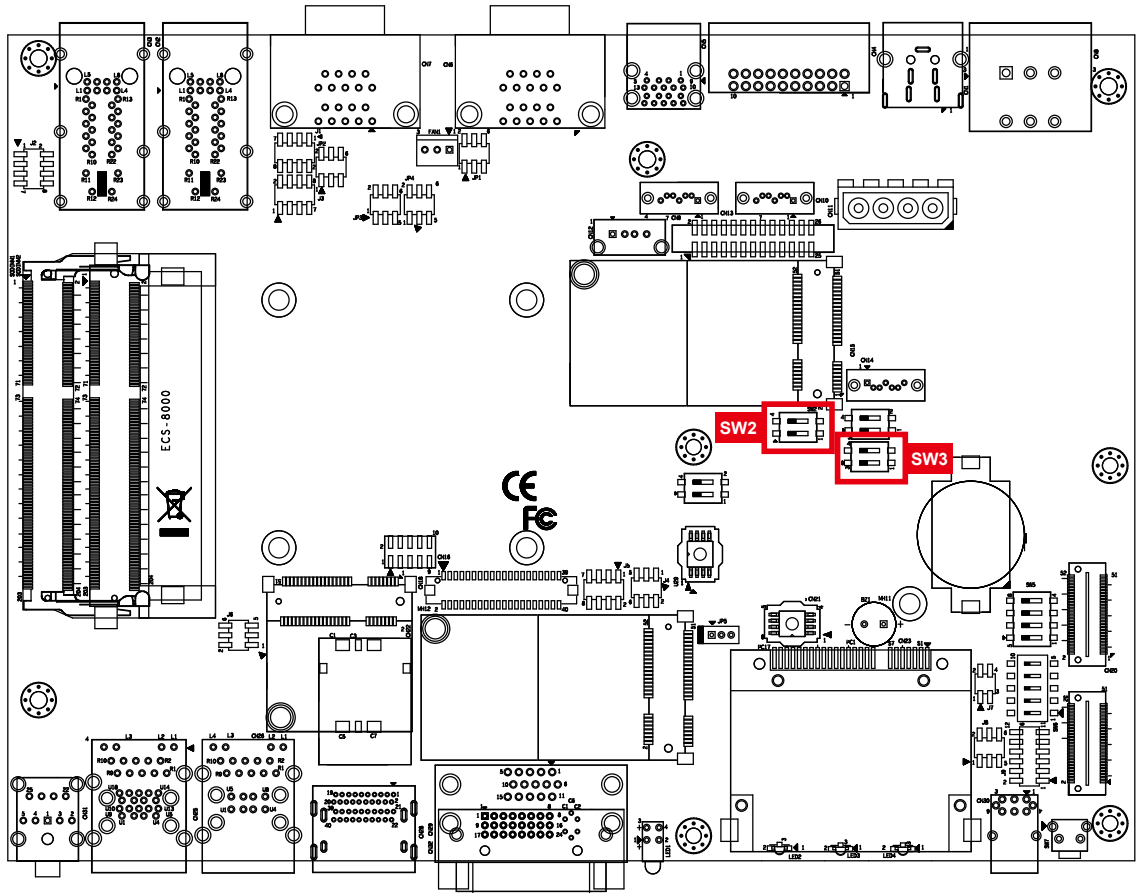

Function	DIP Switch SW 2-1	Description
COM1 RS-422/485 Receiver Terminator	ON	*Enable
	OFF	Disable

Function	DIP Switch SW 2-2	Description
COM2 RS-422/485 Receiver Terminator	ON	*Enable
	OFF	Disable

Function	DIP Switch SW 3-1	Description
COM3 RS-422/485 Receiver Terminator	ON	*Enable
	OFF	Disable

Function	DIP Switch SW 3-2	Description
COM4 RS-422/485 Receiver Terminator	ON	*Enable
	OFF	Disable

## 2.5.6 SW1, SW4: mini PCIe / mSATA Selection

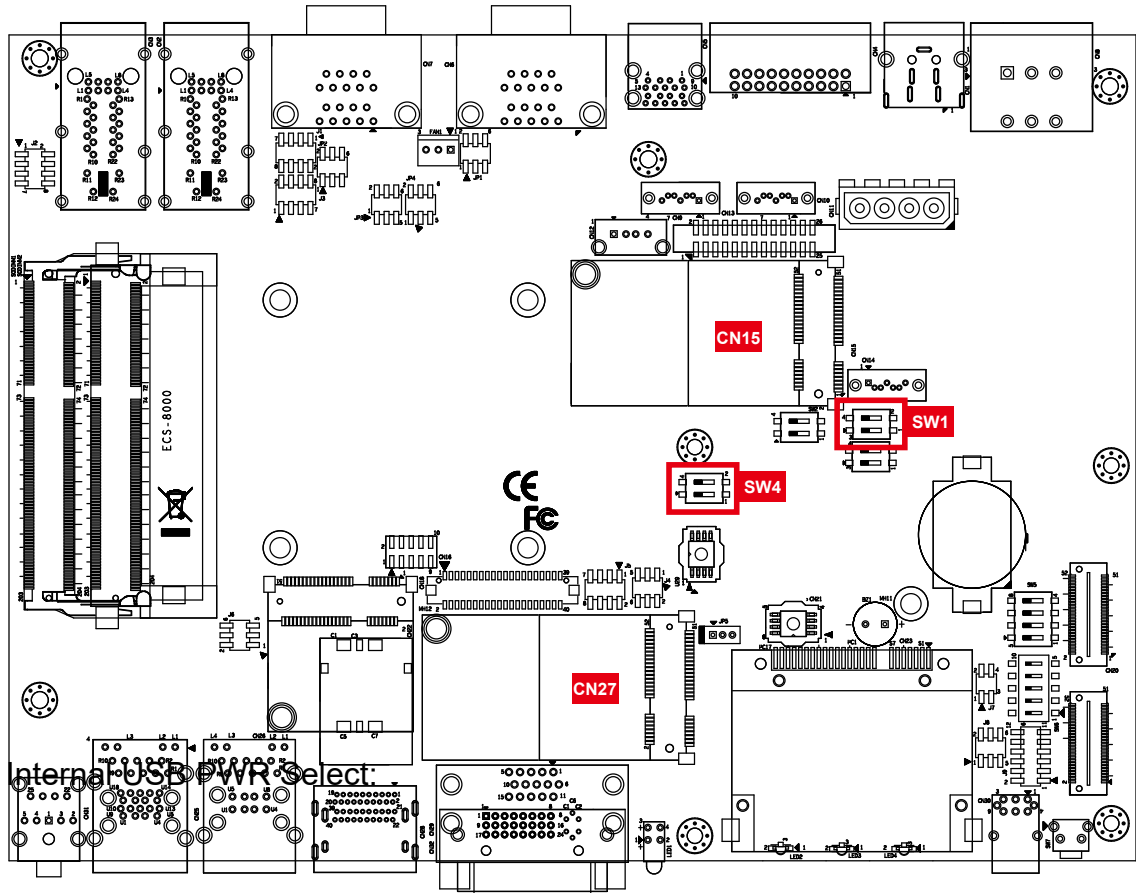

Mini PCIe / mSATA	DIP Switch		Description
	SW 4-1	SW 4-2	
CN27	ON	OFF	*Auto Detection
	OFF	ON	Mini PCI-E (Forced)
	OFF	OFF	mSATA (Forced)

Mini PCIe / mSATA	DIP Switch		Description
	SW 1-1	SW 1-2	
CN15	ON	OFF	*Auto Detection
	OFF	ON	Mini PCI-E (Forced)
	OFF	OFF	mSATA (Forced)

## 2.6 Ignition Control



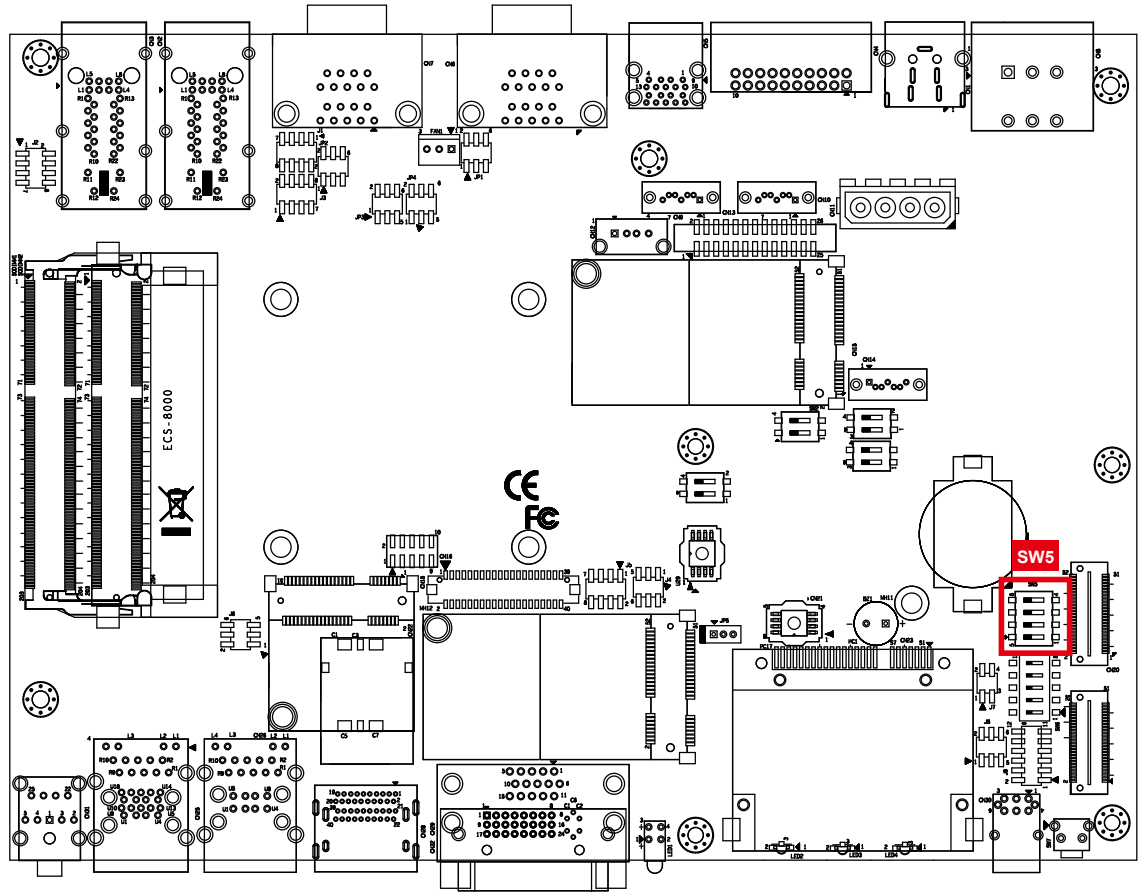













ECS-8000 series provides ignition power control feature for in-vehicle applications. The built-in MCU monitors the ignition signal and turns on/ off the system according to pre-defined on/ off delay period.



## 2.6.1 Adjust Ignition Control Modes

ECS-8000 series provides 16 modes of different power on/ off delay periods adjustable via rotary switch. The default rotary switch is set to 0 in ATX/ AT power mode.

The modes are listed in below table:

DIP-Switch Position	Power on delay	Power off delay	Switch Position
0	ATX/AT mode		
1	No delay	No delay	
2	No delay	5 seconds	
3	No delay	10 seconds	
4	No delay	20 seconds	
5	5 seconds	30 seconds	
6	5 seconds	60 seconds	
7	5 seconds	90 seconds	
8	5 seconds	30 minutes	
9	5 seconds	1 hour	
A	10 seconds	2 hours	
B	10 seconds	4 hours	
C	10 seconds	6 hours	
D	10 seconds	8 hours	
E	10 seconds	12 hours	
F	10 seconds	24 hours	



## 2.6.2 Ignition Control Wiring

To activate ignition control, you need to provide IGN signal via the 3-pin pluggable terminal block locates in the back panel. Please find below the general wiring configuration.

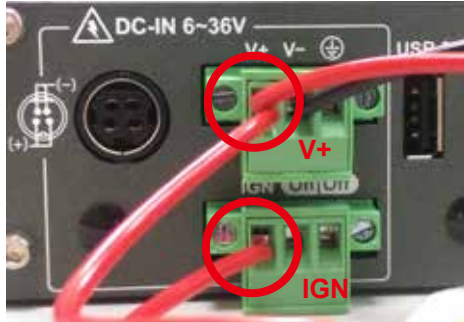

**V+** : Positive polarity of DC power input (Car battery+ for 12/24/36V)

**V-** : Ground of DC power input (Car battery -/GND line to GND)

**IGN** : Ignition signal input (ACC power of vehicle)

For testing purpose, you can refer to the picture blow to simulate ignition signal input controlled by a latching switch.

Note:

1. DC power source and IGN share the same ground.
2. ECS-8000 supports 6V to 36V wide range DC power input in ATX/AT mode. In Ignition mode, the input voltage is fixed to 12/24/36V for car battery scenario.
3. For proper ignition control, the power button setting should be “Power Down” mode.

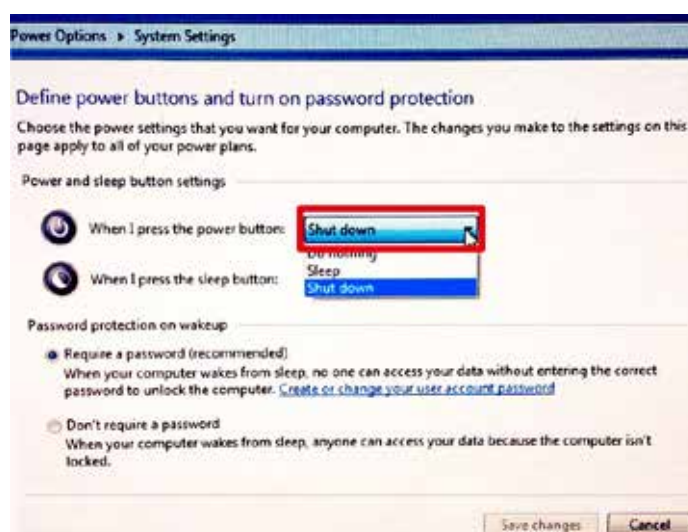

In Windows for example, you need to set “When I press the power button” to Shut down.

# 3

## SYSTEM SETUP

“Please make sure to assemble the system in an anti-static environment.”

### 3.1 How to Open Your ECS-8000

#### 3.1.1 ECS-8000-PoER/ ECS-8000-2R

**Step 1** Remove 6 pcs KHS #6-32 screws with front panel.



**Step 2** Take off the front panel.



**Step 3** Remove 5 pcs KHS #6-32 screws with rear panel.



**Step 4** Remove 4 pcs F#6-32(red) screws.



**Step 5** Finish.



### 3.1.2 ECS-8000-PoE/ ECS-8000-2G

**Step 1** Remove 6 pcs KHS #6-32 screws with front panel.



**Step 2** Take off the front panel.



**Step 3** Remove 5 pcs KHS #6-32 screws with rear panel.



**Step 4** Remove 1 pcs M3x6 (red) and 4 pcs F#6-32 (blue) screws.



**Step 5** Take off SSD/HDD cover and bottom cover, be careful SATA cable.



**Step 6** Finish.



## 3.2 Installing DDR3L SO-DIMM Modules

- Step 1** Install DDR3L RAM module into SO-DIMM slot.  
(ECS-8000-PoER/ ECS-8000-PoE/ ECS-8000-2G/ ECS-8000-2R)



- Step 2** Make sure the RAM module is locked by the memory slot.  
(ECS-8000-PoER/ ECS-8000-PoE/ ECS-8000-2G/ ECS-8000-2R)

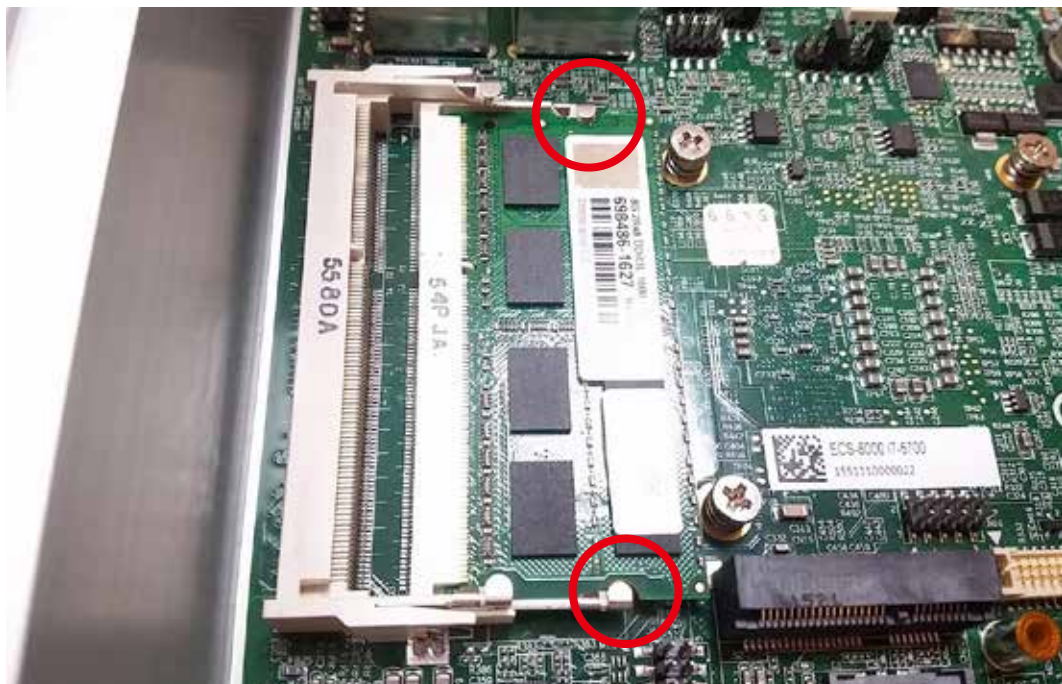

### 3.3 Installing Mini PCIe Cards

**Step 1** Install Mini PCIe card into the Mini PCIe slot.  
(ECS-8000-PoER/ ECS-8000-PoE/ ECS-8000-2G/ ECS-8000-2R)



**Step 2** Fasten M2.5 screws.  
(ECS-8000-PoER/ ECS-8000-PoE/ ECS-8000-2G/ ECS-8000-2R)





### 3.4 Installing Antenna Cable

**Step 1** Check Antenna cable and washers.



**Step 2** Remove 3pcs rubber cork on rear panel.  
(Pick up the location you want)



**Step 3** Put Antenna cable connector into the hole on rear panel.



**Step 4** Fasten the washer 1, washer 2 and washer 3 on Antenna cable connector.



**Step 5** Antenna cable is installed ready.



### 3.5 Installing CFast Card and SIM Card

**Step 1** Remove 2pcs M3x4 Flat head screws on CFast & SIM Card cover on front panel.



**Step 2** Remove CFast Card and SIM Card cover from front panel.



**Step 3** Before Inserting CFast & SIM Card, make sure the system power is not plugged.

**Step 4** Insert CFast & SIM Card, push to lock.



## 3.6 Installing SSD/HDD

### 3.6.1 ECS-8000-PoER/ ECS-8000-2R

**Step 1** Open the SSD/ HDD tray on the ECS-8000 front panel.



**Step 2** Put on the SSD/HDD.



**Step 3** Push the tray panel with locked.



**Step 4** Have a key can fasten the tray.

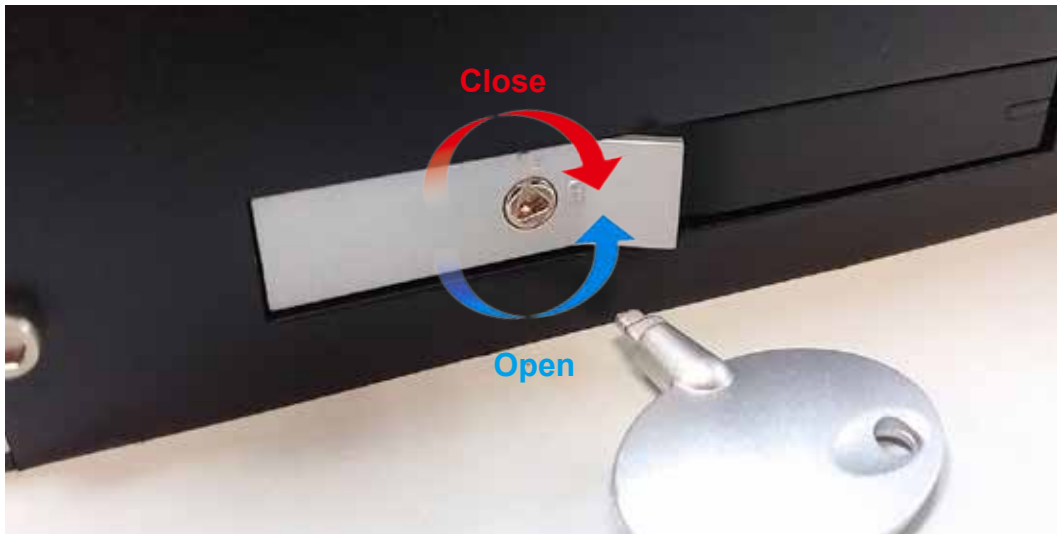

### 3.6.2 ECS-8000-PoE/ ECS-8000-2G

**Step 1** Remove M3x6 screws for SSD/ HDD cover.



**Step 2** Insert 2.5" SSD/ HDD in the tray then match SSD/ HDD bracket with screw hole.



**Step 3** Locked 8 pcs M3 screws in SSD/ HDD screw hole.



**Step 4** Insert SATA cable with SSD/ HDD.



**Step 5** Close the SSD/ HDD cover.



**Step 6** Fasten M3x6 screw with SSD/HDD cover.





### 3.7 Mounting ECS-8000

**Step 1** Ensure the screw holes on the right and left side of upper case match the ones on ECS-8000 wallmount bracket.



**Step 2** Fasten 4pcs KHS#6-32 screws.



# 4

## BIOS AND DRIVER SETTING

### 4.1 BIOS Settings

The board uses UEFI BIOS that is use Serial Peripheral Interface (SPI) Flash. The SPI Flash contains the BIOS Setup program, POST, the PCI auto-configuration utility, LAN, EEPROM information, and Serial port support. The BIOS setup program is accessed by pressing the <Del> key after the Power-On Self-Test (POST) memory test begins and before the operating system boot begins. The menu bar is shown below.

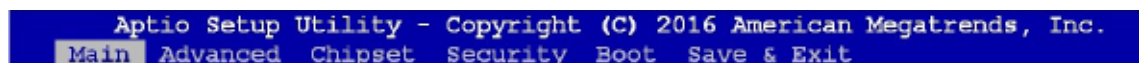

Figure 4-1-1: BIOS Menu Bar

### 4.2 Main Menu

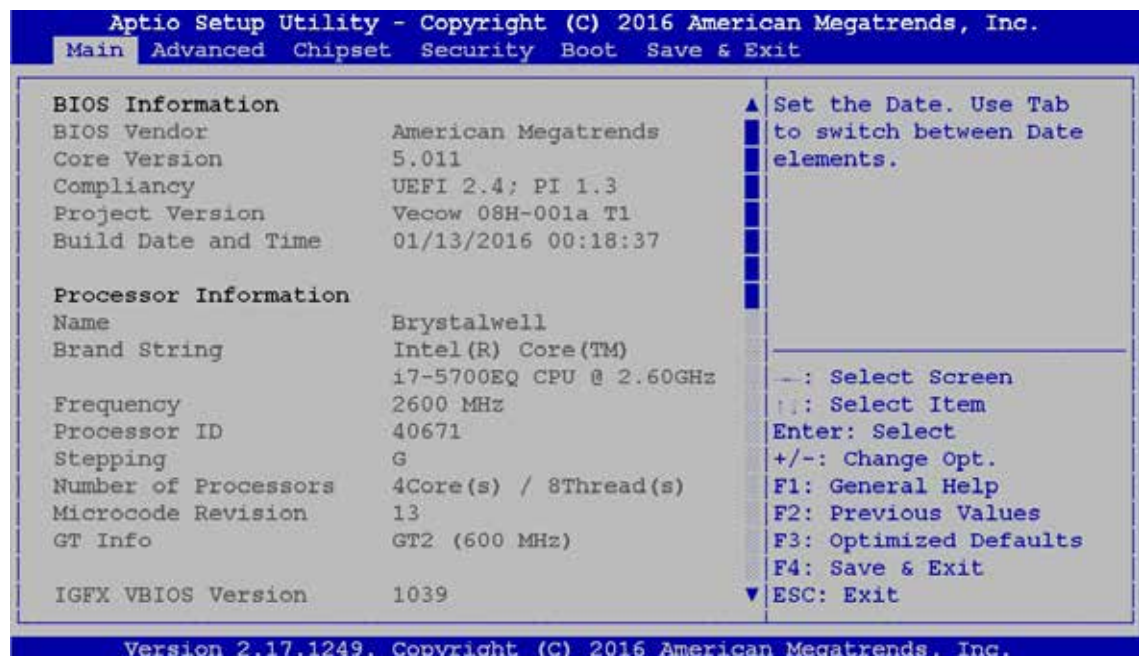

Figure 4 2: BIOS Main screen

In this page, you could make sure you CPU type and DRAM type that you are install into this system.

## 4.2.1 System Time/Date Setting

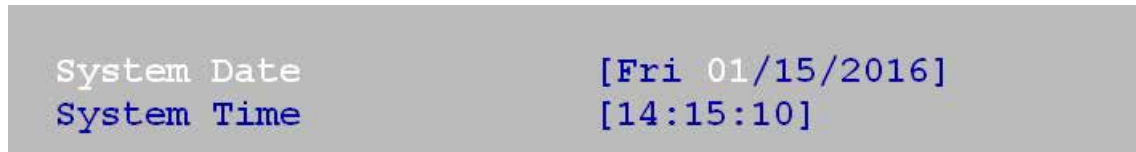

Figure 4-2-1: System Time / Date setting

### System Time/ Date

Press “TAB” key to switch sub-items of value .Then press “+” key or “-“ key number key for modify value.

## 4.3 Advanced Function

### 4.3.1 ACPI Setting



Figure 4-3-1: ACPI Setting setup screen

### Enable ACPI Auto Configuration

This system support ACPI function as auto process. You should Enable/ Disable that depend as your OS.

### Enable Hibernation

It is able to use Hibernate function if OS support. But some OS may not be effective with this function.

### 4.3.2 CPU Configuration

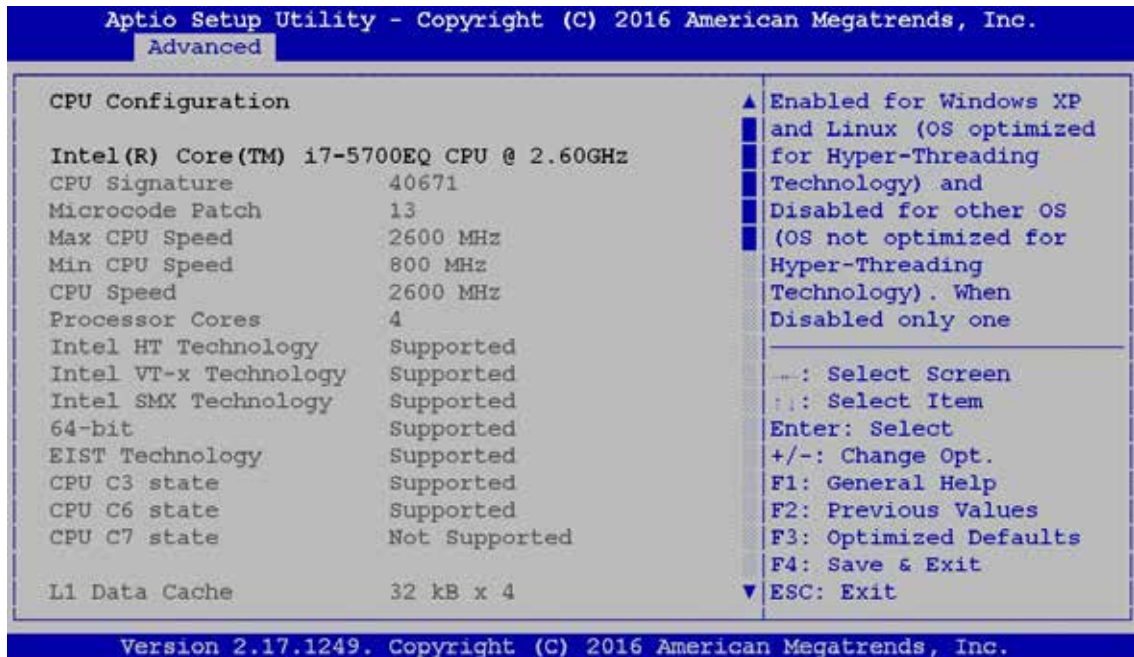

Figure 4-3-2: CPU Configuration setup screen

### Intel Virtualization Technology

This for Virtualization Application or platform usage, when enabled, a VMM can utilize the additional hardware capabilities provided by Vanderpool Technology.

### 4.3.3 SATA Configuration

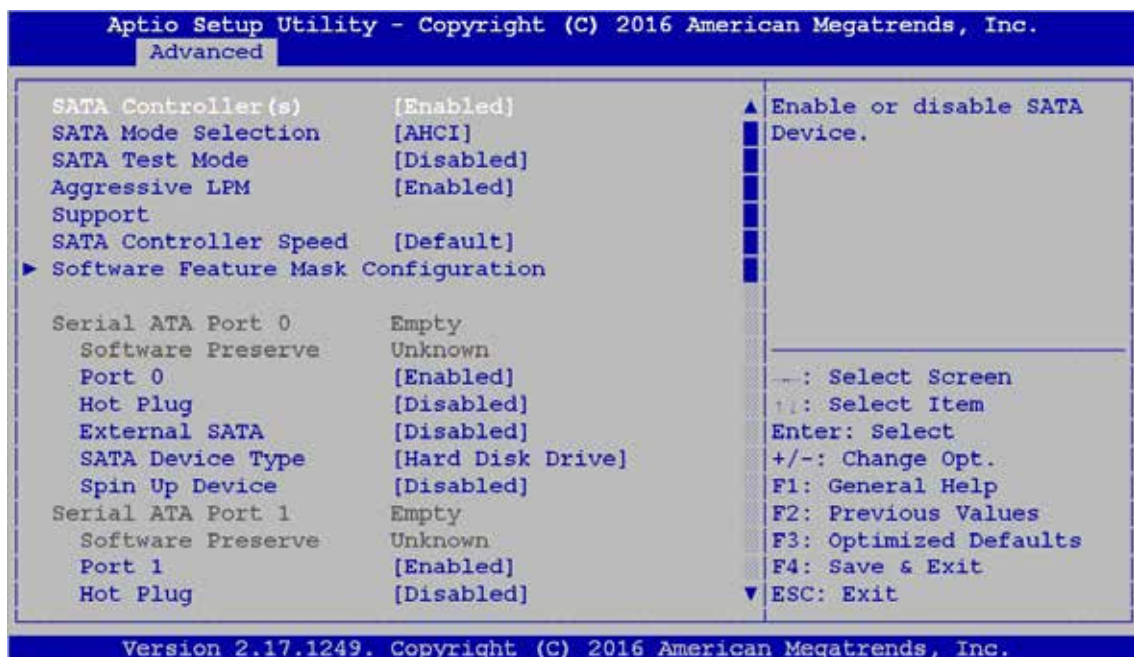

Figure 4-3-3 : SATA Configuration setup screen

## SATA Controller(s)

Enables or Disables integrate SATA controller for Storage device use.

## SATA Mode Selection

Determines how the SATA transfer mode for operate. Here have three option for choice [IDE] / [AHCI] / [RAID]. For the RAID mode operate, please see appendix E. for detail information.

## Serial ATA Port 0 to Port 3

This system offers six SATA ports for connection SATA device.

## 4.3.4 AMT Configuration



Figure 4-3-4: AMT Setup screen

## Intel AMT

Enables or Disables Intel® Active Management Technology BIOS extension. This option just controls the BIOS extension executes.

### 4.3.5 Serial Port 1 Configuration

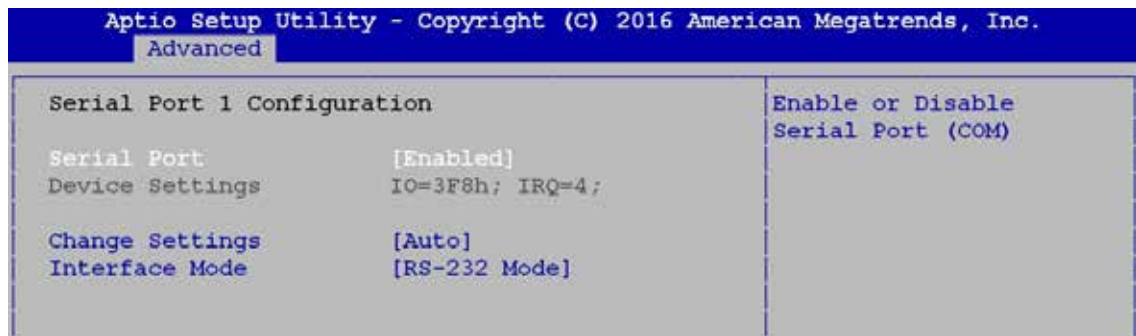

Figure 4-3-5 : Serial Port 1 Setup screen

#### Serial Port

Enable or Disable Serial Port.

#### Device Setting

Current IO address and interrupt resource of Serial Port.

#### Change Settings

Select another device setting.  
There are 6 options as follow :

- Auto
- IO=3F8h; IRQ=4;
- IO=3F8h; IRQ=3,4,10,11;
- IO=2F8h; IRQ=3,4,10,11;
- IO=3E8h; IRQ=3,4,10,11;
- IO=2E8h; IRQ=3,4,10,11;

#### Interface Mode

There are 4 options as follow :

- RS-232 Mode
- RS-422 Mode
- RS-485 Mode
- Loop Back

## 4.3.6 Serial Port 2 Configuration

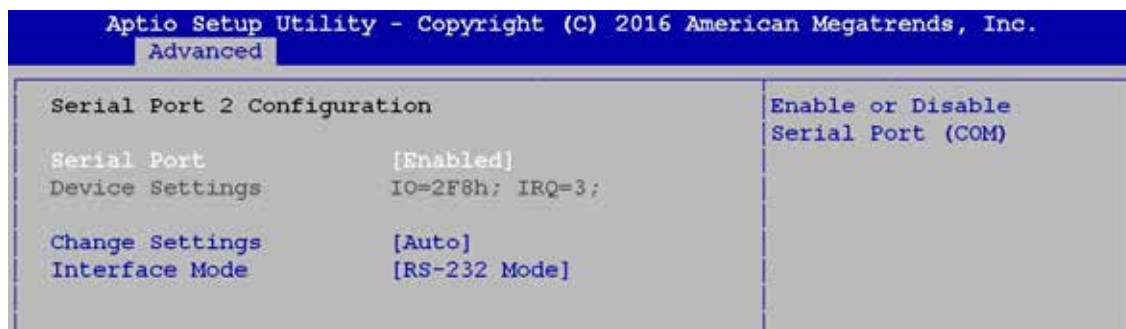

Figure 4-3-6 : Serial Port 2 Setup screen

### Serial Port

Enable or Disable Serial Port.

### Device Setting

Current IO addresses and interrupts resource of Serial Port.

### Change Settings

Select another device setting.

There are 6 options as follow :

- Auto
- IO=2F8h; IRQ=3;
- IO=3F8h; IRQ=3,4,10,11;
- IO=2F8h; IRQ=3,4,10,11;
- IO=3E8h; IRQ=3,4,10,11;
- IO=2E8h; IRQ=3,4,10,11;

### Interface Mode

There are 4 options as follow :

- RS-232 Mode
- RS-422 Mode
- RS-485 Mode
- Loop Back

### 4.3.7 Serial Port 3 Configuration

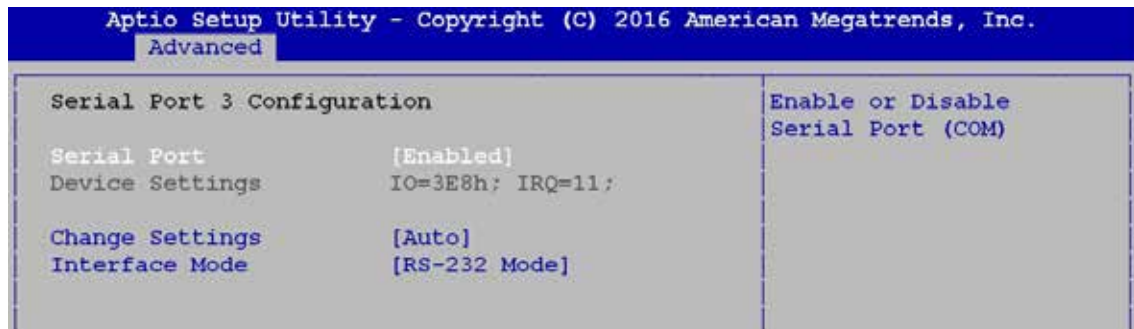

Figure 4-3-7 : Serial Port 3 Setup screen

#### Serial Port

Enable or Disable Serial Port.

#### Device Setting

Current IO address and interrupt resource of Serial Port.

#### Change Settings

Select another device setting.  
There are 6 options as follow :

- Auto
- IO=3E8h; IRQ=11;
- IO=3E8h; IRQ=3,4,10,11;
- IO=2E8h; IRQ=3,4,10,11;
- IO=2F0h; IRQ=3,4,10,11;
- IO=2E0h; IRQ=3,4,10,11;

#### Interface Mode

There are 4 options as follow :

- RS-232 Mode
- RS-422 Mode
- RS-485 Mode
- Loop Back



## 4.3.8 Serial Port 4 Configuration

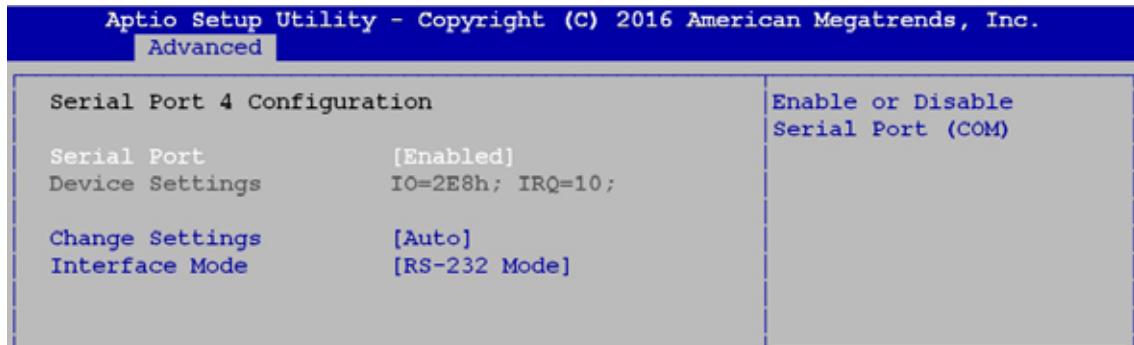

Figure 4-3-8 : Serial Port 4 Setup screen

### Serial Port

Enable or Disable Serial Port.

### Device Setting

Current IO address and interrupt resource of Serial Port.

### Change Settings

Select another device setting.

There are 6 options as follow :

- Auto
- IO=2E8h; IRQ=10;
- IO=3E8h; IRQ=3,4,10,11;
- IO=2E8h; IRQ=3,4,10,11;
- IO=2F0h; IRQ=3,4,10,11;
- IO=2E0h; IRQ=3,4,10,11;

### Interface Mode

There are 4 options as follow :

- RS-232 Mode
- RS-422 Mode
- RS-485 Mode
- Loop Back

## 4.4 Chipset Function

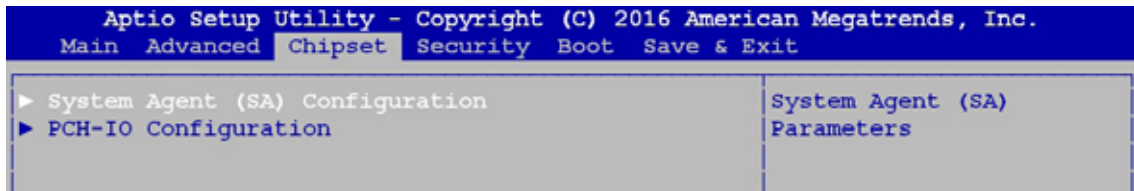

Figure 4-4: Chipset Function Setup screen

Chipset related options for this platform.

### 4.4.1 WOL Configuration

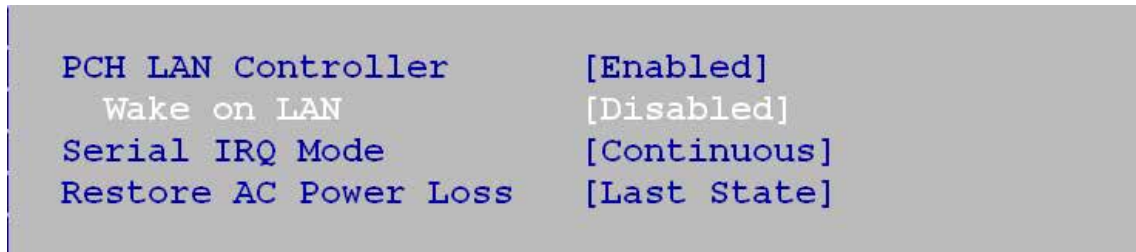

Figure 4-4-1 : Network Setup screen

#### **PCH LAN Controller**

Enable or Disable on board network device.

#### **Wake on LAN**

Enable or Disable integrated LAN to wake the system.

## 4.5 Boot Function

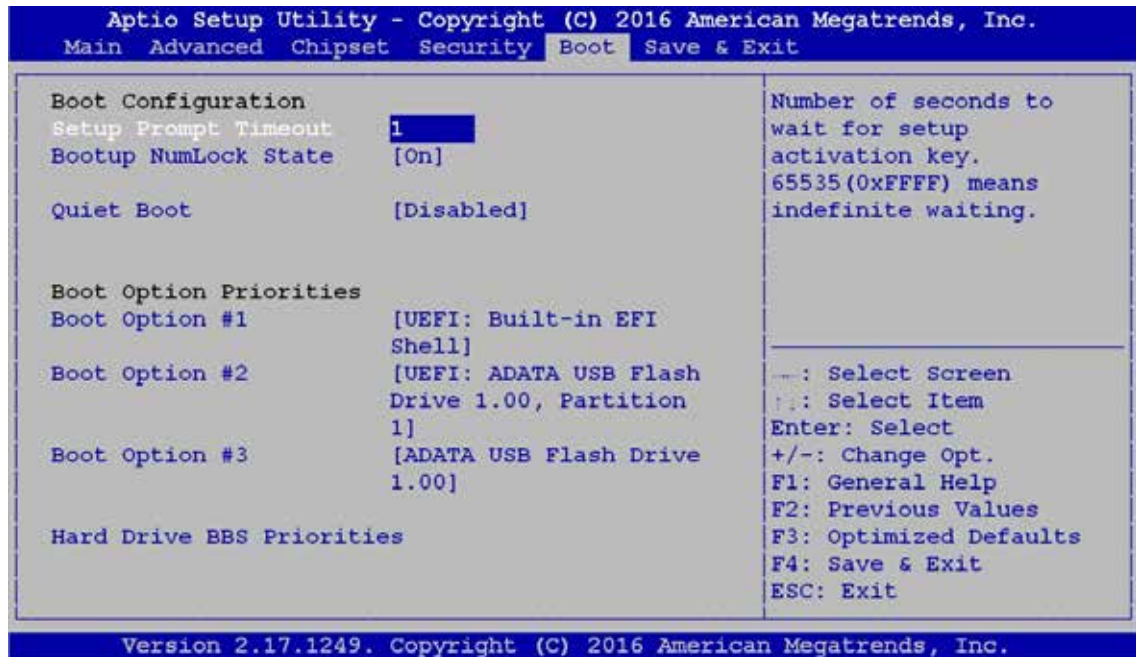

Figure 4-5: Boot function Setup screen

### 4.5.1 Boot Option

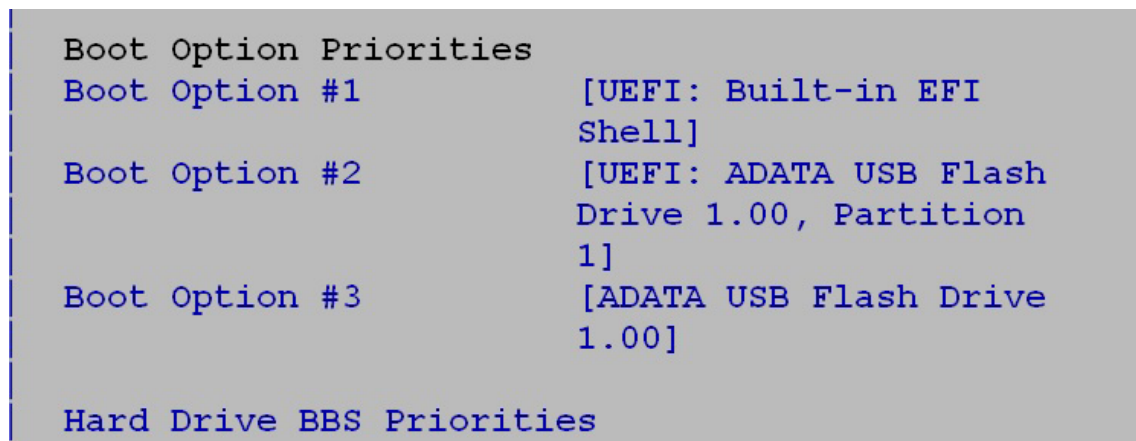

Figure 4-5-1 Boot Option Setup screen

#### Boot option

You can select boot device priority in this page.

## 4.6 Save & Exit

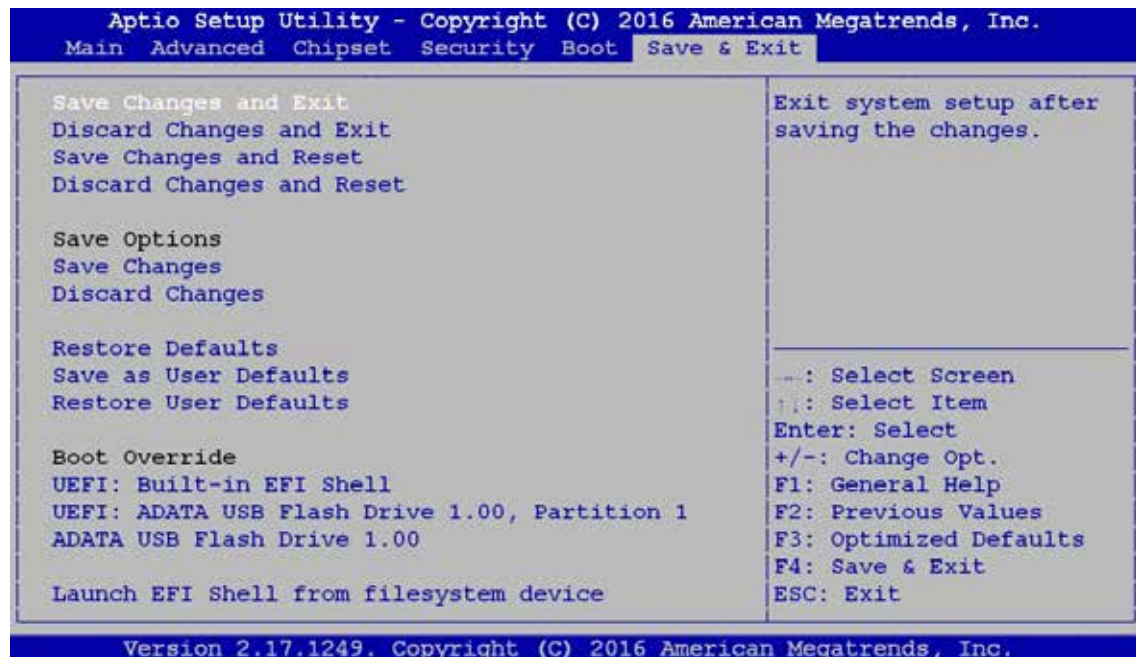

Figure 4-6: Save & Exit Setup screen

### Save Changes and Exit / Save Changes and Reset

Choose this setting to exit the BIOS setup program and save changes to the BIOS NVRAM memory. Make sure you select this in order to keep your changes.

### Discard Changes and Exit / Discard Changes and Reset

Choose this setting to exit the BIOS SETUP program discarding all changes made.

# A

## APPENDIX A : ISOLATED DIO GUIDE

### A.1 I/O Pin Definition

I/O Pin	Base Adr	Usage
GPIO 70~77	0xA06	CN16-GPIO
GPIO 80~87	0xA07	DIO Output

### A.2 Function Description

The ECS-8000 offers a 16-bit DIO (8-DI / 8-DO) 20-pin terminal block connector. Each bit of DI and DO equipped with a photo-coupler for isolated protection. All IO pins are fixed by Hardware design and cannot change in/out direction in runtime process. The definition is shown below:

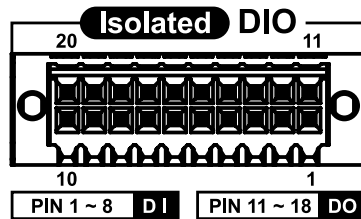

Pin No.	Definition	Description	Pin No.	Definition	Description
1	EXT_IN0	GPIO Input 0	11	EXT_OUT0	GPIO Output 0
2	EXT_IN1	GPIO Input 1	12	EXT_OUT1	GPIO Output 1
3	EXT_IN2	GPIO Input 2	13	EXT_OUT2	GPIO Output 2
4	EXT_IN3	GPIO Input 3	14	EXT_OUT3	GPIO Output 3
5	EXT_IN4	GPIO Input 4	15	EXT_OUT4	GPIO Output 4
6	EXT_IN5	GPIO Input 5	16	EXT_OUT5	GPIO Output 5
7	EXT_IN6	GPIO Input 6	17	EXT_OUT6	GPIO Output 6
8	EXT_IN7	GPIO Input 7	18	EXT_OUT7	GPIO Output 7
9	DI_COM	GPIO COM	19	Reserved	NC
10	EGND	GPIO GND	20	E24V	External 24V DC

Digital GPIO input signal circuit in SINK mode (NPN) is illustrated as follow.

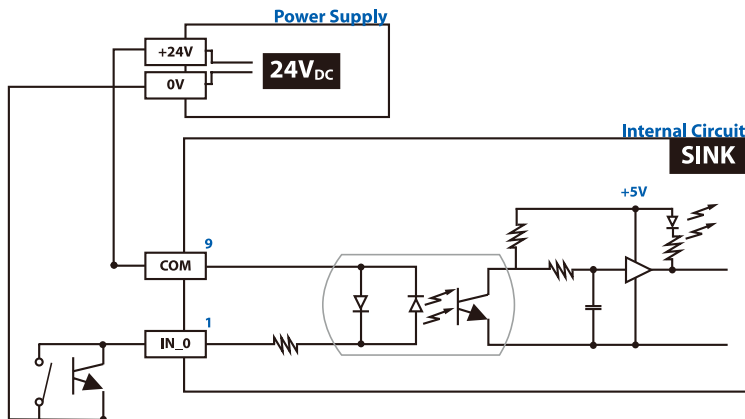

Digital GPIO input signal circuit in SOURCE mode (PNP) is illustrated as follow.

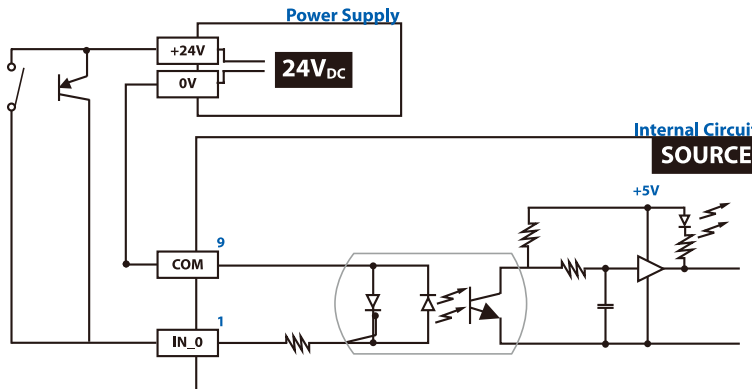

Digital GPIO output signal circuit in SINK mode (NPN) is illustrated as follow.

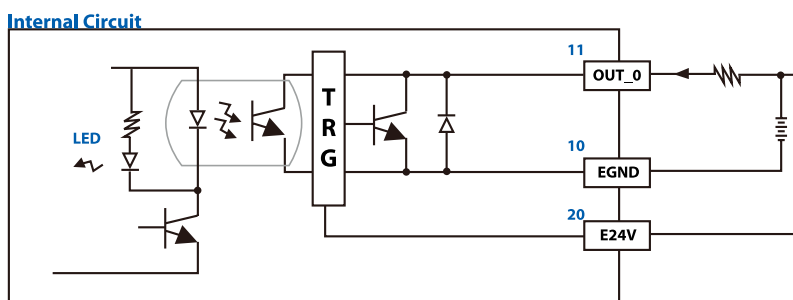

## A.3 Software Package contain

Here have two folders inside :

1. Driver folder include x86 and x64 version.
2. DLL and head file for software developer or System Integration.
3. C# and C++ sample program.

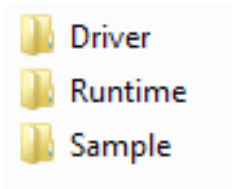

## A.4 Driver Install

This driver only support to 32bit version that are WinXP and Win7 32bit version. Please make sure you O.S before you install it.

Open Console Window as Administrator

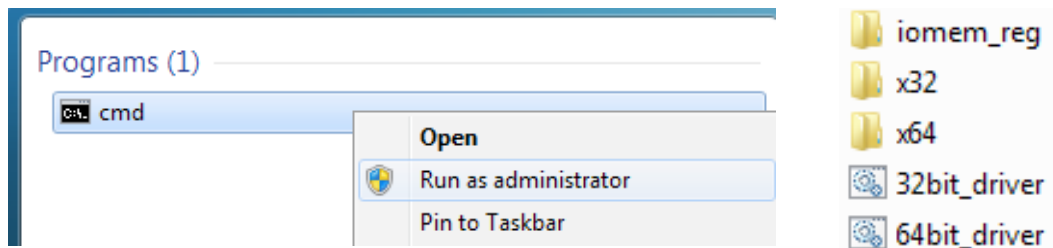

### WinXP :

Please execute "32bit\_driver.bat" on console window as administrator.

### Windows 7 32bit :

Please execute "32bit\_driver.bat" on console window as administrator.

### Windows 7 64bit :

Please execute "64bit\_driver.bat" on console window as administrator.

While execute the driver install process, here shows the Security window popup. Please checked "Always trust software from : Vecow Ltd. Co" and click Install bottom go to next step.

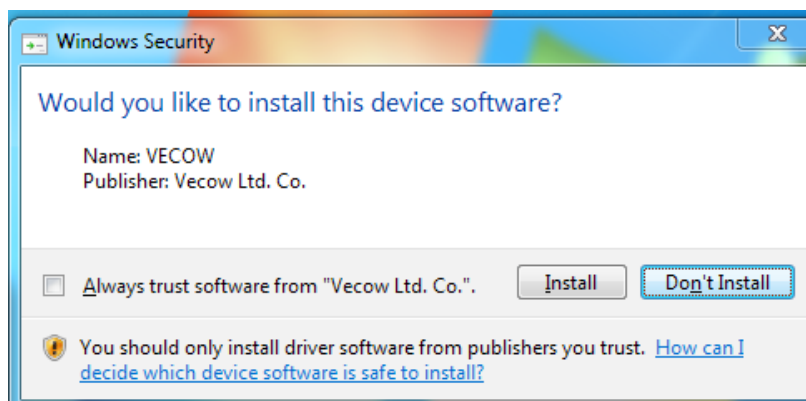

In 64bit version, here have another Window for driver certified. Please agree this license to finish the install process.

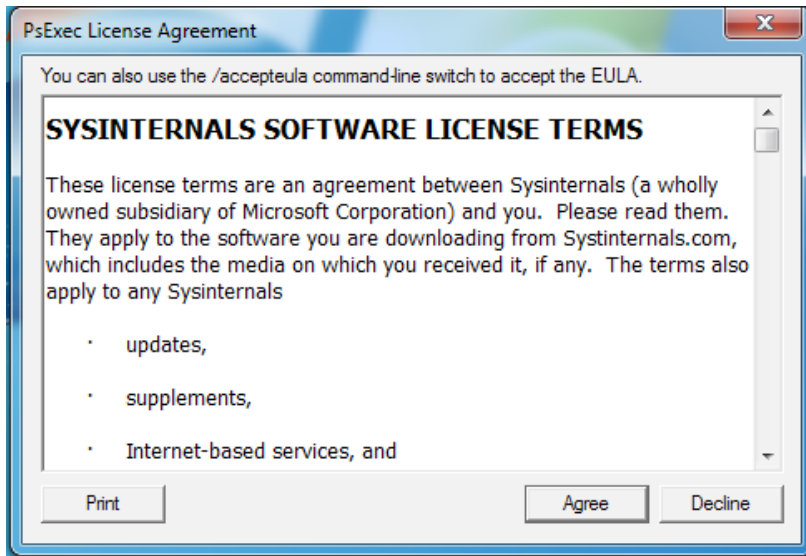

After driver install process complete , you **must restart system** to get DIO driver actived.



# B

## APPENDIX B : GPIO and WDT Functions

### B.1 Function Description

The WDT are using internal Super I/O function. However, you must entry super I/O configuration mode to set it.

Super I/O special address port = 0x2E

Super I/O special data port = 0x2F

GPIO Logical device is 0x07

### B.2 Entry Functions

#### 1. Entry MB PnP Mode.

*//write twice 0x87 value.*

```
outportb(Super I/O special address port, 0x87);  
outportb(Super I/O special address port, 0x01);  
outportb(Super I/O special address port, 0x55);  
outportb(Super I/O special address port, 0x55);
```

#### 2. Located on Logical Device 7(LOGIC\_DEVICE\_WDT)

*//write 0x07 on Reg [0x07] , this setup must follow Step A. that can be workable.*

```
outportb(Super I/O special address port, 0x07);  
outportb(Super I/O special data port, 0x07);
```

#### 3. Config the WDT Register

```
outb(WDT_Config,SPECIAL_ADDRESS_PORT);  
outb(WDT_As_Second|WDT_Pin_PWRGD,SPECIAL_DATA_PORT);
```

#### 4. Start WDT TimeOut Value

Here have 2 Byte for WDT timing count, MSB and LSB should be write the value separate.

<code>WDT_TimeOut_MSB,SPECIAL</code>	<code>WDT_TimeOut_LSB,SPECIAL</code>
--------------------------------------	--------------------------------------

```
outb(WDT_TimeOut_LSB,SPECIAL_ADDRESS_PORT);  
outb(WDT_TimeOutValue,SPECIAL_DATA_PORT);
```



## APPENDIX C: Power Consumption

Testing Board	ECS-8000
RAM	2 x Innodisk 16GB
USB-1	USB Keyboard Logitech K120
USB-2	USB Mouse Microsoft 1113
USB-3	USB Flash Transcend 3.0 8GB
USB-4	USB Flash Transcend 3.0 8GB
USB-5	USB Flash Transcend 2.0 16GB
USB-6	USB Flash Kingston 3.0 8GB
CFAST	Memoright J600 32G
SATA 0	Transcend SSD370 SATA SSD 64GB
SATA 1	Seagate HDD 160GB
LAN 1 (I218)	1.0 Gbps
LAN 2 (I210)	1.0 Gbps
Graphics Output	DVI
Power Plan	Balance (Windows7 Power Plan)
Power Source	Chroma 62006P-100-25

## C.1 CPU : Intel® Core™ i7-5850EQ (6M Cache, 2.70GHz)

### Standby Mode

CPU	Input Power	Max Current	Max Consumption
i7-5850EQ	06V	0.390A	02.34W
i7-5850EQ	09V	0.270A	02.43W
i7-5850EQ	12V	0.290A	03.48W
i7-5850EQ	24V	0.150A	03.60W
i7-5850EQ	28V	0.140A	03.92W
i7-5850EQ	36V	0.120A	04.32W

### Power-on and boot to Win7 64-bit

CPU	Power Input	Idle Status : CPU usage less 3%		Run 100% CPU usage	
		Max Current	Max Consumption	Max Current	Max Consumption
i7-5850EQ	06V	2.680A	16.08W	6.220A	37.32W
i7-5850EQ	09V	1.730A	15.57W	3.960A	35.64W
i7-5850EQ	12V	1.370A	16.44W	2.970A	35.64W
i7-5850EQ	24V	0.720A	17.28W	1.500A	36.00W
i7-5850EQ	28V	0.610A	17.08W	1.280A	35.84W
i7-5850EQ	36V	0.490A	17.64W	1.040A	37.44W

## C.2 CPU : Intel® Core™ i7-5850EQ (6M Cache, 2.60GHz)

### Standby Mode

CPU	Input Power	Max Current	Max Consumption
i7-5700EQ	06V	0.390A	02.34W
i7-5700EQ	09V	0.270A	02.43W
i7-5700EQ	12V	0.230A	02.76W
i7-5700EQ	24V	0.150A	03.60W
i7-5700EQ	28V	0.130A	03.64W
i7-5700EQ	36V	0.120A	04.32W

### Power-on and boot to Win7 64-bit

CPU	Power Input	Idle Status : CPU usage less 3%		Run 100% CPU usage	
		Max Current	Max Consumption	Max Current	Max Consumption
i7-5700EQ	06V	2.820A	16.92W	5.830A	34.98W
i7-5700EQ	09V	1.850A	16.65W	3.680A	33.12W
i7-5700EQ	12V	1.350A	16.20W	2.870A	34.44W
i7-5700EQ	24V	0.690A	16.56W	1.380A	33.12W
i7-5700EQ	28V	0.590A	16.52W	1.190A	33.32W
i7-5700EQ	36V	0.470A	16.92W	0.930A	33.48W

For ignition control, the standby mode consume less than 4mA.



For further support information, please visit [www.vecow.com](http://www.vecow.com)

This document is released for reference purpose only.

All product offerings and specifications are subject to change without prior notice.

No part of this publication may be reproduced in any form or by any means, electric, photocopying, recording or otherwise, without prior authorization of the publisher.

The rights of all the brand names, product names and trademarks belong to their respective owners.

© Vecow Co., Ltd. 2021. All rights reserved.